

FG6RA Series

High Efficiency Upflow/Horizontal Gas Furnace

**Induced Draft - 80+ AFUE
Input 45,000 - 144,000 Btuh**

The high efficiency upflow/horizontal gas furnace may be installed free standing in a utility room, basement, or enclosed in an alcove or closet. The extended flush jacket provides a pleasing "appliance appearance." Design certified by the Canadian Standards Association (CSA). The product is truly designed with the contractor and the consumer in mind.

FEATURES and BENEFITS

- **Best warranty in the business** —
 - A full 20 years on the heat exchanger
 - 8 Year Limited Parts, 5 Year Quality Pledge
- **100% fired and tested** — All units and each component (both mechanical and electrical) are tested on the manufacturing line.
- **Best packaging in the industry** — Unique design assures product will arrive to the homeowner dent free.
- **Clean and quiet operation** — Due to the unique design of in-shot burners, location of inducer, return air vents, and use of insulation.
- **Fixed 30 second blower delay** at burner start-up assures a warm duct temperature at furnace start-up. Adjustable blower off settings (60, 90, 120 and 180 seconds).
- **Fixed 30 second post purge** increases life of heat exchanger.
- **SmartLite™ Control Board** — Provides extended life to ignitors in furnaces using hot surface ignition technology. Programmed to learn the heat-up characteristics of the ignitor, then adapt the ignition time to the characteristics of the furnace so the ignitor is energized appropriately.
- **Dependable, hot surface ignitor** — Innovative application of an appliance type ignitor with a 20 year history of reliability.
- **Color coded wire harness** — Designed to fit the components, all with quick-connect fittings for ease of service and replacement.
- **Approved for categories I and III venting systems** — May be common, dedicated, or horizontal vented for maximum flexibility in installation.
- **Tubular primary heat exchanger** — Heavy gauge aluminized steel heat exchanger assures a long life.
- **90 second fixed cooling cycle blower-off delay (TDR)** increases cooling performance when matched with a NORDYNE coil.
- **Fully insulated blower cabinet** for quiet operation.
- **Variable speed blower kit** is available to maximize air conditioner and heat pump efficiencies. On selected units, SEER ratings up to 14 and HSPF ratings up to 8.5 are ARI listed.
- **Multi-speed direct drive blower** — Designed to give a wide range of cooling capacities. 40VA transformer included.
- **LP convertible** — Simple burner orifice and regulator spring change for ease of convertibility.
- **Diagnostic lights flash to identify limit failure, pressure switch failure, improper ground and polarization, and low flame signal** — for easy troubleshooting.
- **Incorporates integrated control board** with connections for electronic air cleaner, humidifier and twinning.
- **Two piece door design** enhances furnace appearance and uses screw fasteners for easier accessibility.
- **3 amp fuse** protection against low voltage shorts; protects transformer and control board.
- **Low voltage terminal board** for easy field wiring.
- **Components and Controls** — Designing quality into our products means selecting manufacturers that have a reputation for delivering high quality, dependable products.

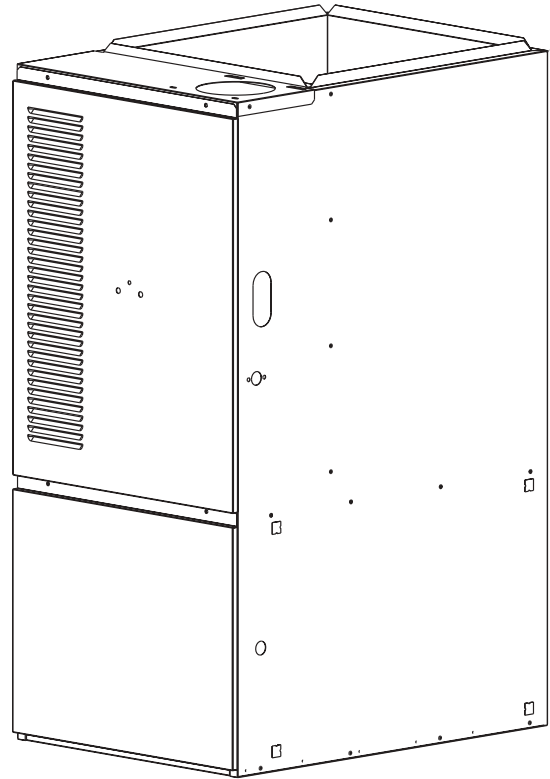

FEATURES

High Efficiency Upflow/Horizontal 80+ Gas Furnace

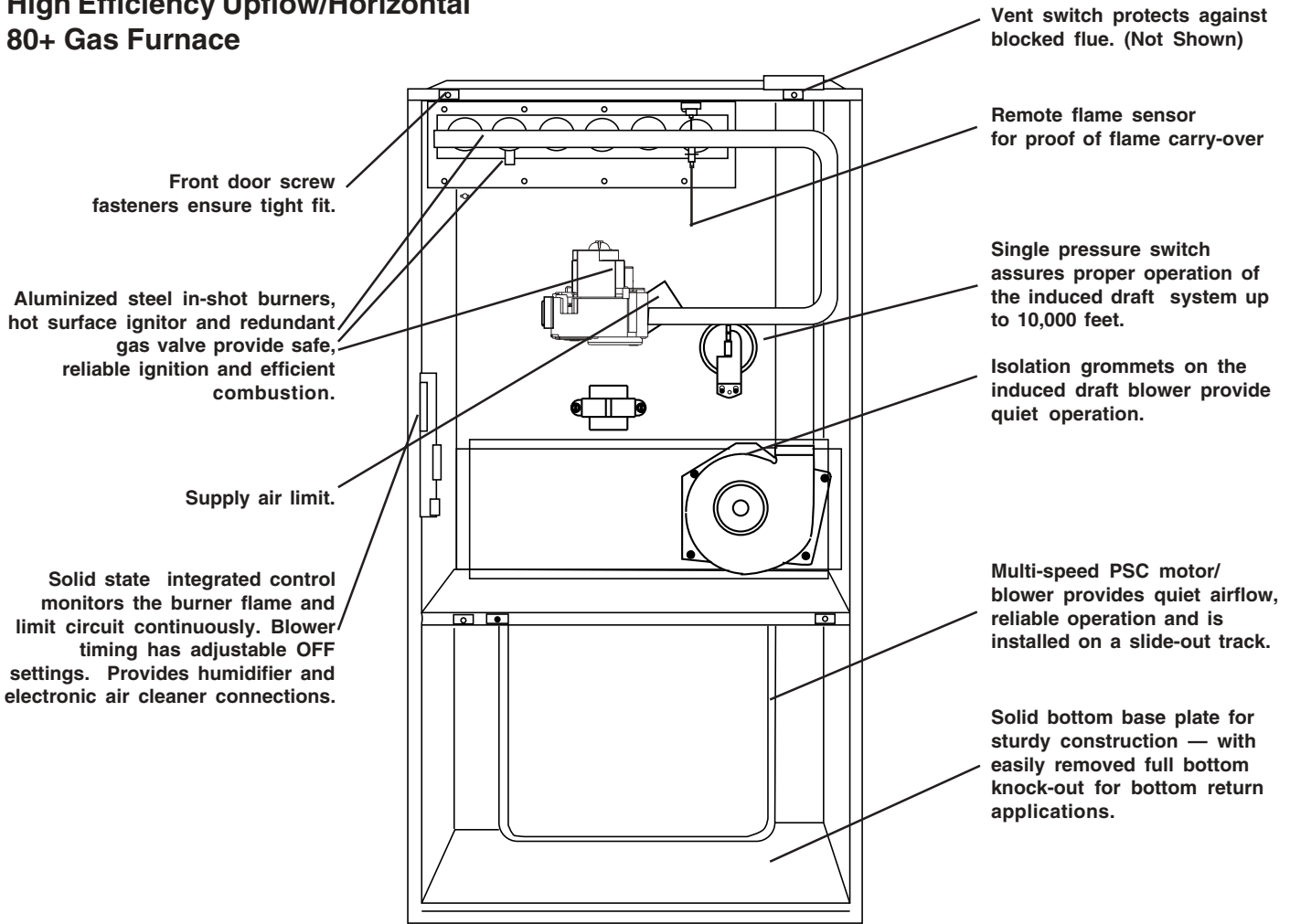

STANDARD EQUIPMENT

Draft inducer; pressure switch; redundant main gas control; hot-surface ignition; timed ON/OFF blower controls (TDR) ; 40VA transformer for air conditioner application; limit controls; solid base plate with knock-out for easy removal; direct drive motor; all models can be converted to use L.P. (propane) gas. Factory approved kits *only* must be used and are available as an optional accessory from your distributor.

SPECIFICATIONS

FG6RA MODEL NUMBERS	-045()08A	-060()12A	-072()12A	-072()16B	-072()17A	-096()12B	-096()16B	-096()20B	-096()20C	-120()16B	-120()20C	-144()20C
Input-Btuh (a)	45,000	60,000	72,000	72,000	72,000	96,000	96,000	96,000	96,000	120,000	120,000	144,000
Heating Capacity - Btuh	36,000	48,000	58,000	58,000	58,000	77,000	77,000	77,000	77,000	96,000	96,000	115,000
AFUE	80+	80+	80+	80+	80+	80+	80+	80+	80+	80+	80+	80+
Max. Htg. Ext. St. Press. In W.C.	.5	.5	.5	.5	.5	.5	.5	.5	.5	.5	.5	.5
Blower Wheel D x W	10 x 6	10 x 6	10 x 6	10 x 10	10 x 6	10 x 9	10 x 10	11 x 10	11 x 10	10 x 10	11 x 10	11 x 10
Motor H.P. -Speed -Type	1/5-3-PSC	1/3-3-PSC	1/3-3-PSC	1/2-4-PSC	3/4-4-PSC	1/3-3-PSC	1/2-4-PSC	3/4-4-PSC	3/4-4-PSC	1/2-4-PSC	3/4-4-PSC	3/4-4-PSC
Motor FLA	2.8	6.0	6.0	7.9	14.0	6.0	7.9	11.1	11.1	7.9	11.1	11.1
Temperature Rise Range - °F	45 - 75	45 - 75	45 - 75	40 - 70	45 - 75	50 - 80	50 - 80	50 - 80	40 - 70	50 - 80	45 - 75	45 - 75
Approximate Shipping Wt. - lbs.	123	134	135	152	135	163	163	170	174	174	182	194

All models are 115 V, 60 HZ. Gas connections are 1/2" N.P.T.

AFUE= Annual Fuel Utilization Efficiency

(a) Ratings to 2000 ft. Over 2000 ft. reduce 4% for each 1000 ft. above sea level

DIMENSIONS

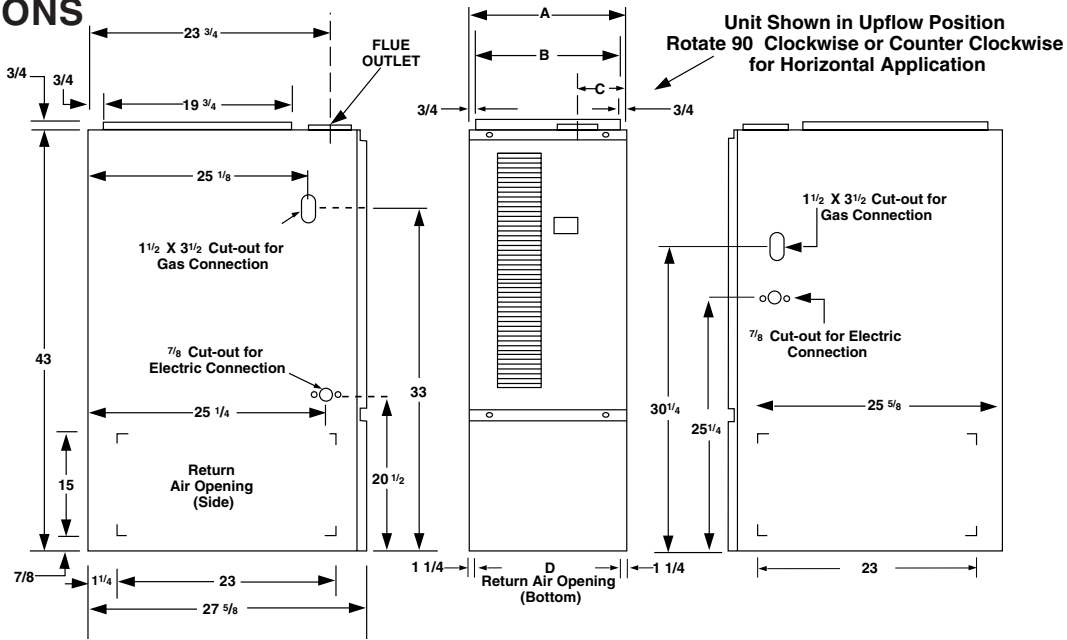

MODEL NUMBER FG6RA-	A (in.)	B (in.)	C (in.)	D (in.)	MODEL NUMBER FG6RA-	A (in.)	B (in.)	C (in.)	D (in.)
045()08A	14 1/4	12 3/4	3 1/4	11 3/4	096()16B	19 3/4	18 1/4	3 3/4	17 1/4
060()12A	14 1/4	12 3/4	3 3/4	11 3/4	096()20B	19 3/4	18 1/4	3 3/4	17 1/4
072()12A	14 1/4	12 3/4	3 3/4	11 3/4	096()20C	22 1/2	21	3 3/4	20
072()16B	19 3/4	18 1/4	3 3/4	17 1/4	120()16B	19 3/4	18 1/4	3 3/4	17 1/4
072()17A	14 1/4	12 3/4	3 3/4	11 3/4	120()20C	22 1/2	21	3 3/4	20
096()12B	19 3/4	18 1/4	3 3/4	17 1/4	144()20C	22 1/2	21	4 1/4	20

BLOWER PERFORMANCE

Model Number *RA-	Heating Input (Btuh)	Motor Speed	Motor HP	External Static Pressure (Inches Water Column)															
				0.1		0.2		0.3		0.4		0.5		0.6		0.7		0.8	
				CFM	Rise	CFM	Rise	CFM	Rise	CFM	Rise	CFM	Rise	CFM	Rise	CFM	Rise	CFM	Rise
045(t)-08A	45000	High*	1/5	1000	33	970	34	950	35	920	36	870	38	820	41	770	43	700	48
		Medium**		760	44	740	45	730	46	720	46	690	48	670	50	640	52	620	54
		Low		630	53	620	54	610	55	600	56	570	58	540	62	510	65	470	71
060(t)-12A	60000	High*	1/3	1380	32	1350	33	1310	34	1260	35	1210	37	1150	39	1080	41	1000	44
		Medium**		1220	36	1190	37	1160	38	1120	40	1070	42	1020	44	950	47	880	51
		Low		820	54	800	56	780	57	760	58	730	61	700	63	670	66	640	69
072(t)-12A	72000	High*	1/3	1380	39	1350	40	1310	41	1260	42	1210	44	1150	46	1080	49	1000	53
		Medium**		1220	44	1190	45	1160	46	1120	48	1070	50	1020	52	950	56	880	61
		Low		820	65	800	67	780	68	760	70	730	73	700	76	670	80	640	83
072(t)-16B	72000	High*	1/2	1980	27	1910	28	1830	29	1760	30	1660	32	1570	34	1460	37	1350	40
		Med-High		1710	31	1660	32	1610	33	1540	35	1470	36	1390	38	1300	41	1200	44
		Med-Low**		1490	36	1470	36	1420	38	1380	39	1320	40	1250	43	1170	46	1090	49
072(t)-17A	72000	High*	3/4	1950	27	1900	28	1810	29	1770	30	1730	31	1700	31	1700	31	1670	32
		Med-High		1500	36	1450	37	1420	38	1380	39	1340	40	1310	41	1280	42	1250	43
		Med-Low**		1160	46	1130	47	1090	49	1060	50	1030	52	980	54	940	57	900	59
096(t)-12B	96000	High*	1/3	1530	46	1450	49	1390	51	1300	55	1220	58	1130	63	1040	68	940	76
		Medium**		1380	52	1320	54	1250	57	1190	60	1100	65	1020	70	920	77	820	87
		Low		930	76	900	79	870	82	820	87	750	95	670	106	580	123	470	151
096(t)-16B	96000	High*	1/2	1980	36	1910	37	1840	39	1760	40	1680	42	1590	45	1500	47	1410	50
		Med-High**		1720	41	1670	43	1610	44	1560	46	1480	48	1410	50	1320	54	1230	58
		Med-Low		1470	48	1440	49	1410	50	1370	52	1320	54	1270	56	1200	59	1130	63
096(t)-20B	96000	High*	3/4	2435	29	2410	30	2375	30	2335	30	2290	31	2215	32	2135	33	2035	35
		Med-High**		2015	35	2015	35	2005	35	1975	36	1945	37	1905	37	1895	38	1865	38
		Med-Low		1698	42	1695	42	1680	42	1660	43	1645	43	1600	44	1555	46	1495	48
096(t)-20C	96000	High*	3/4	2340	30	2290	31	2280	31	2180	33	2150	33	2080	34	2000	36	1920	37
		Med-High		1910	37	1880	38	1860	38	1830	39	1810	39	1790	40	1770	40	1750	41
		Med-Low**		1520	47	1510	47	1490	48	1480	48	1460	49	1440	49	1420	50	1400	51
120(t)-16B	120000	High*	1/2	1900	47	1830	49	1750	51	1630	55	1580	56	1490	60	1400	63	1320	67
		Med-High**		1720	52	1670	53	1610	55	1560	57	1480	60	1410	63	1320	67	1230	72
		Med-Low		1450	61	1420	63	1380	64	1340	66	1280	69	1220	73	1150	77	1070	83
120(t)-20C	120000	High*	3/4	2300	39	2250	40	2190	41	2130	42	2090	43	2040	44	2000	44	1950	46
		Med-High**		1910	47	1880	47	1860	48	1830	49	1800	49	1770	50	1740	51	1700	52
		Med-Low		1540	58	1530	58	1520	58	1500	59	1480	60	1450	61	1420	63	1390	64
144(t)-20C	144000	High*	3/4	2240	48	2190	49	2130	50	2070	52	2020	53	1960	54	1910	56	1850	58
		Med-High**		1900	56	1860	57	1820	59	1780	60	1740	61	1700	63	1660	64	1620	66
		Med-Low		1520	70	1510	71	1490	72	1480	72	1450	74	1420	75	1390	77	1360	78
Low	1330	80	1310	81	1290	83	1280	83	1250	85	1230	87	1210	88	1180	90			

† Can be C or N

Notes: 1. Airflow rates of 1800 CFM or more require two return air connections. Data is for operation with filter(s).

* Factory Set Cooling Speed

2. Temperature rises in the table are approximate. Actual temperature rises may vary.

** Factory Set Heating Speed

3. Temperature rises and airflows for external static pressures greater than 0.5 are for reference only. These conditions are not recommended.

- Not Recommended

MODEL IDENTIFICATION CODE

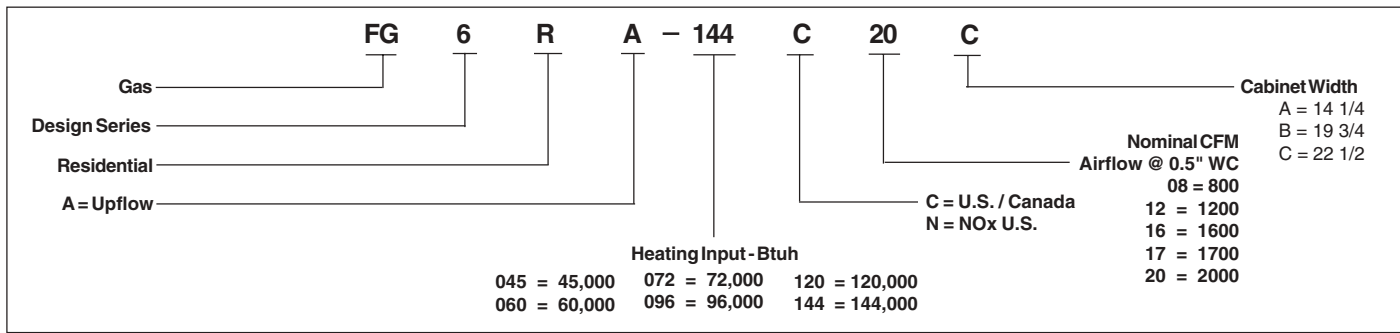

Through-the-Wall VENTING Venting Requirements

These furnaces are approved to use with 3" single wall AL29-4C stainless steel vent pipe in horizontal vent applications, and with the required horizontal vent kit listed below. The pipe is available from the following manufacturers:

- Z-Flex Inc.** - vent brand name (**Z-VENT**)
- Heat-fab Inc.** - vent brand name (**Saf-T Vent**)
- Flex-L International** - vent brand name (**STAR-34 Vent**)

When venting horizontal, this is a Category III furnace, the vent pressure is positive, and the venting system must be sealed in both horizontal and vertical runs.

Model Number FG6RA-	Min. Pipe Size	Reducer Needed	Flue Outlet (in.)	Max. # Elbows	Max. Ft. Vent Pipe
045(-)08A	3"	None	3	4	35
060(-)12A	3"	4" to 3"	4	4	35
072(-)12A	3"	4" to 3"	4	4	35
072(-)16B	3"	4" to 3"	4	4	35
096(-)12B	3"	4" to 3"	4	4	35
096(-)16B	3"	4" to 3"	4	4	35
096(-)20B	3"	4" to 3"	4	4	35
096(-)20C	3"	4" to 3"	4	4	35
120(-)16B	3"	4" to 3"	4	4	35
120(-)20C	3"	4" to 3"	4	4	35
144(-)20C*	3"	4" to 3"	5	3	30

* NOTE: Field supplied special 5" to 4" Reducer Kit required for model FG6RA144C-120.

ACCESSORIES

High Efficiency 80+ with Honeywell VR Gas Valve		
Kit		Order Number
U.S. LP Conversion Kit (0 to 10,000 ft.)		904090A
Canadian LP Gas Conversion Kit (0 to 4,500 ft.)		904091A
Fossil Fuel Kit		914762
Side Return Filter Kit		541036
Bottom Return Filter (20/Box)	A Cabinet	903088
	B Cabinet	903089
	C Cabinet	903090
Horizontal Vent Kit		903196
Internal Side Return Filter Wire		903152
Variable Speed Blower Kit for "A" Cabinets		904231
Variable Speed Blower Kit for "B" & "C" Cabinets		903756A

VENTING

All models, with the exception of the reduced NOx models, are approved for vertical and horizontal venting applications (see table above). All models may be common vented with a gas water heater. Type B gas vent materials may be used when connected to a vertical vent system. The installation must be in accordance with the venting instructions supplied with the furnace.

Furnace Model Number *RA,*RK	Furnace Input (Btu/hr)	Cabinet Width (in.)	Nominal Electrical Supply	Maximum Operating Voltage	Minimum Operating Voltage	Maximum Furnace Amperes	Minimum Wire Gauge	Maximum Fuse or Circuit Breaker Amps**
045(t)-08	45,000	14.25	115-60-1	127	103	5.6	14	15
060(t)-12	60,000	14.25	115-60-1	127	103	7.1	14	15
072(t)-12	72,000	14.25	115-60-1	127	103	7.1	14	15
072(t)-16	72,000	19.75	115-60-1	127	103	9.0	14	15
072(t)-17	72,000	14.25	115-60-1	127	103	21.0	10	35
096(t)-12	96,000	19.75	115-60-1	127	103	7.1	14	15
096(t)-16	96,000	19.75	115-60-1	127	103	9.0	14	15
096(t)-20	96,000	22.50	115-60-1	127	103	12.2	12	20
120(t)-16	120,000	19.75	115-60-1	127	103	9.0	14	15
120(t)-20	120,000	22.50	115-60-1	127	103	12.2	12	20
135(t)-20	135,000	22.50	115-60-1	127	103	12.2	12	20
144(t)-20	144,000	22.50	115-60-1	127	103	12.2	12	20

Note: (t) can be C or N.
 **Time-delay fuses or HACR-type circuit breakers are required.

Thermostat Wire Gauge	Recommended Thermostat Wire Length	
	2-wire (heating)	4 or 5-wire (cooling)
24	55 ft.	25 ft.
22	90 ft.	45 ft.
20	140 ft.	70 ft.
18	225 ft.	110 ft.



974A-0305 (Replaces 974A-0902)