

Outdoor Air Conditioner

User's Information and Installation Instructions

13+ SEER Extra High Efficiency Split System

These units have been designed and tested for capacity and efficiency in accordance with A.R.I. Standards. Split System Air Conditioning units are designed for use with a wide variety of fossil fuel furnaces, electric furnaces, air handlers, and evaporator coil combinations.

These instructions are primarily intended to assist qualified individuals experienced in the proper installation of heating and/or air conditioning appliances. Some local codes require licensed installation/service personnel for this type of equipment. Read all instructions carefully before starting the installation.

USER'S INFORMATION

IMPORTANT

Read this owner information to become familiar with the capabilities and use of your appliance. Keep this with literature on other appliances where you have easy access to it in the future.

If a problem occurs, check the instructions and follow recommendations given. If these suggestions don't eliminate your problem, call your servicing contractor.

OPERATING INSTRUCTIONS

To Operate Your Air Conditioner for Cooling —

1. Set the thermostat system switch to COOL or AUTO and the thermostat fan switch to AUTO. (See Figure 1)
2. Set the thermostat temperature to the desired temperature level using the temperature selector. Please refer to the separate thermostat user's manual for complete instructions regarding thermostat programming. The outdoor unit and indoor blower will both cycle on and off to maintain the indoor temperature at the desired cooling level.

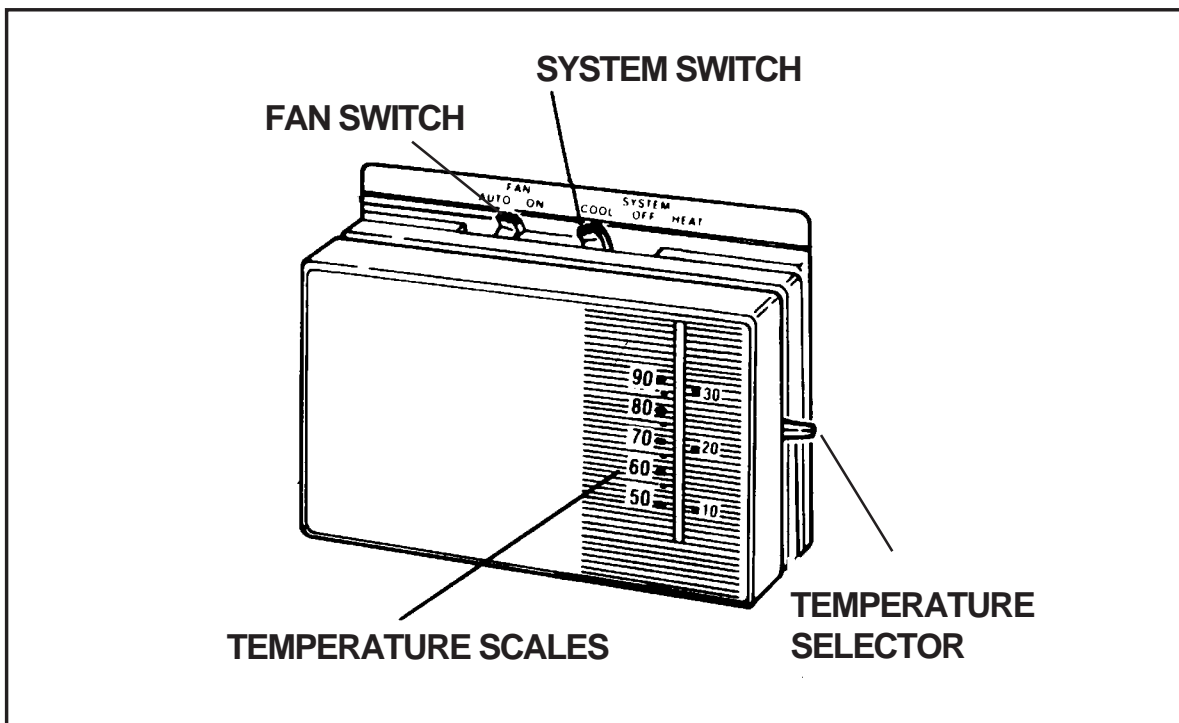

Figure 1. Typical Thermostat

To Operate Your Furnace for Heating —

1. Set the thermostat system switch to HEAT or AUTO and the thermostat fan switch to AUTO. (See Figure 1)
2. Set the thermostat temperature to the desired temperature level using the temperature selector. Please refer to the separate user's manual for complete thermostat programming instructions. The furnace and indoor blower will cycle on and off to maintain the indoor temperature at the desired heating level.

To Shut Off Your Air Conditioner —

Set the thermostat system switch to OFF and the thermostat fan switch to AUTO. (See Figure 1)

The system will not operate, regardless of the thermostat temperature setting.

To Operate the Indoor Blower Continuously —

Set the thermostat fan switch to ON (See Figure 1)

The indoor blower will start immediately, and will run continually until the fan switch is reset to AUTO.

The continuous indoor blower operation can be obtained with the thermostat system switch set in any position, including OFF.

The continuous indoor blower operation is typically used to circulate the indoor air to equalize a temperature unbalance due to a sun load, cooking, or fireplace operation.

To Maintain Your Air Conditioner —

**CAUTION:**

Be certain the electrical power to the outdoor unit and the furnace/air handler is disconnected before doing the following recommended maintenance.

1. Regularly:

- a. Clean or replace the indoor air filter at the start of each heating and cooling season, and when an accumulation of dust and dirt is visible on the air filter.
- b. Remove any leaves and grass clippings from the coil in the outdoor unit, being careful not to damage the aluminum fins.
- c. Check for any obstruction, such as twigs, sticks, etc.
- d. Certain models have external panels fabricated from a premium grade of stainless steel designed to inhibit corrosion. For such units, if the unit is located in a coastal region or other area subjected to high concentrations of salt, then the unit should be hosed off after storms and monthly otherwise to maintain its new appearance.

2. Before Each Cooling Season:

If the furnace/air handler blower motor and the outdoor unit fan motor(s) have oil tubes at the motor bearings, apply 10 drops of SAE No. 20 motor oil to each oil tube.

**CAUTION:**

Do not over-oil, or oil motors not factory-equipped with oil tubes. The compressor is hermetically “sealed” and does not require lubrication.

3. Before Calling a Service Technician, Be Certain:

- a. The unit thermostat is properly set—see “To Operate Your Air Conditioner for Cooling” and “To Operate Your Furnace for Heating.”
 - b. The unit disconnect fuses are in good condition, and the electrical power to the unit is turned on.
-

1. GENERAL INFORMATION

Read the following instructions completely before performing the installation.

Condensing Unit Section — Each condensing unit is shipped with a refrigerant charge adequate to operate the outdoor section with an indoor matching coil or air handler, and 15 feet of refrigeration line.

NOTE: DO NOT USE ANY PORTION OF THE CHARGE FOR PURGING OR LEAK TESTING.

Matching coils and air handlers are shipped with a small pressurized holding charge to pressurize them to keep out contaminants. To release the pressure, carefully read the installation instructions provided with the indoor coil or air handler.

Liquid and Suction Lines — Refrigerant grade copper tubing should be used when installing the system. Refrigerant suction line tubing should be fully insulated.

Field Connections for Electrical Power Supply — All wiring must comply with current revisions of the National Electrical Code (ANSI/NFPA 70) and with applicable local codes having jurisdiction. The minimum size of electrical conductors and circuit protection must be in compliance with information listed on the outdoor unit data label.

2. SAFETY CONSIDERATIONS

Pressures within the System — Split system air conditioning equipment contains liquid and gaseous refrigerant under pressure. Installation and servicing of this equipment should be performed by qualified, trained personnel thoroughly familiar with this type of equipment. Under no circumstances should the Homeowner attempt to install and/or service the equipment.

Labels, Tags, Precautions — When working with this equipment, follow all precautions in the literature, on tags, and on labels provided with the equipment. Read and thoroughly understand the instructions provided with the equipment prior to performing the installation and operational checkout of the equipment.

Brazing Operations — Installation of equipment may require brazing operations. Safety codes must be complied with. Safety equipment (e.g.; safety glasses, work gloves, fire extinguisher, etc.) must be used when performing brazing operations.

**WARNING:**

Ensure all electrical power to the unit is off prior to installing or servicing the equipment. Failure to do so may cause personal injury or death.

3. SITE PREPARATION

Unpacking Equipment — Remove the cardboard carton and User's Manual from the equipment. Take care not to damage the tubing connections when removing the carton.

Inspect for Damage — Inspect the equipment for damage prior to installing the equipment at the job site. Ensure coil fins are straight and, if necessary, comb fins to remove flattened and bent fins.

Preferred Location of the Outdoor Unit at the Job Site — Conduct a survey of the job site to determine the optimum location for mounting the outdoor unit. Overhead obstructions, poorly ventilated areas, and areas subject to accumulation of debris should be avoided. The outdoor unit should be installed no closer than 18 inches from the outside walls of the facility and in an area free from overhead obstructions to ensure unrestricted airflow through the outdoor unit.

Facility Prerequisites — Electrical power must be supplied to the equipment. Electrical power supplied must be adequate for proper operation of the equipment. The system must be wired and provided with circuit protection in accordance with local building codes and the National Electrical Code.

Minimum Circuit Ampacity — Electrical wiring to the equipment must be compatible and in compliance with the minimum circuit ampacity listed on the outdoor unit data label.

Maximum Fuse/Circuit Breaker Size — Circuit protection for the outdoor unit must be compatible with the maximum fuse/circuit breaker size listed on the outdoor unit data label.

4. INSTALLING THE OUTDOOR UNIT

Slab Mount — The site selected for a slab mount installation requires a stable foundation and one

not subject to erosion. The slab should be level and anchored (if necessary) prior to placing the equipment on the slab.

Cantilever Mount — The cantilever mount should be designed with adequate safety factor to support the weight of the equipment, and for loads subjected to the mount during operation. Installed equipment should be adequately secured to the cantilever mount and levelled prior to operation of the equipment.

Roof Mount — The method of mounting should be designed so as not to overload roof structures nor transmit noise to the interior of the structure. Refrigerant and electrical line should be routed through suitably waterproofed openings to prevent water leaking into the structure.

5. INSTALLING THE INDOOR UNIT

The indoor section should be installed before proceeding with routing of refrigerant piping. Consult the installation instructions of the indoor unit (i.e.: air handler, furnace, etc.) for details regarding installation.

6. CONNECTING REFRIGERANT TUBING BETWEEN THE INDOOR AND OUTDOOR UNIT

General — Once outdoor and indoor unit placement has been determined, route refrigerant tubing between the equipment in accordance with sound installation practices. Refrigerant tubing should be routed in a manner that minimizes the length of tubing and the number of bends in the tubing. Refrigerant tubing should be supported in a manner that the tubing will not vibrate or abrade during system operation. Tubing should be kept clean of foreign debris during installation and installation of a liquid line filter drier is recommended if cleanliness or adequacy of system evacuation is unknown or compromised. Every effort should be made by the installer to ensure that the field installed refrigerant containing components of the system have been installed in accordance with these instructions and sound installation practices so as to insure reliable system operation and longevity. The maximum recommended interconnecting refrigerant line length is 75 feet, and the vertical elevation dif-

ference between the indoor and outdoor sections should not exceed 20 feet.

Filter Dryer Installation — A filter dryer is provided with PS series models only and must be installed in the liquid line of the system. If the installation replaces a system with a filter dryer already present in the liquid line, the filter dryer must be replaced with the one supplied with the unit. The filter dryer must be installed in strict accordance with the manufacturer's installation instructions.

For all other series models, installing a filter dryer is optional. However, it is good installation practice to install a filter dryer when replacing the evaporator and/or condenser of a system. When installing, the filter dryer must be installed in strict accordance with the manufacturer's installation instructions.

Optional Equipment — Optional equipment (e.g.: liquid line solenoid valves, etc.) should be installed in strict accordance with the manufacturer's installation instructions.

7. MAKING ELECTRICAL CONNECTIONS

WARNING:

Turn off all electrical power at the main circuit box before wiring electrical power to the outdoor unit. Failure to comply may cause severe personnel injury or death.

Wiring Diagram/Schematic — A wiring diagram/schematic is located on the inside cover of the electrical box of the outdoor unit. The installer should become familiar with the wiring diagram/schematic before making any electrical connections to the outdoor unit.

Outdoor Unit Connections — The outdoor unit requires both power and control circuit electrical connections. Refer to the unit wiring diagram/schematic for identification and location of outdoor unit field wiring interfaces.

Control Circuit Wiring — The outdoor unit is designed to operate from a 24 VAC Class II control circuit. Control circuit wiring must comply with

the current provisions of the National Electrical Code (ANSI/NFPA 70) and with applicable local codes having jurisdiction.

Thermostat Connections — Thermostat connections should be made in accordance with the instructions supplied with the thermostat, and with the instructions supplied with the indoor equipment.

Electrical Power Wiring — Electrical power wiring shall comply with the current provisions of the National Electrical Code (ANSI/NFPA 70) and with applicable local codes having jurisdiction. Use of rain tight conduit is recommended. Electrical conductors shall have minimum circuit ampacity in compliance with the outdoor unit rating label. The facility shall employ electrical circuit protection at a current rating no greater than that indicated on the outdoor unit rating label.

Disconnect Switch — An electrically compatible disconnect switch must be within line of sight of the outdoor unit. This switch shall be capable of electrically de-energizing the outdoor unit.

Optional Equipment — Optional equipment requiring connection to the power or control circuits must be wired in strict accordance with current provisions of the National Electrical Code (ANSI/NFPA 70), with applicable local codes having jurisdiction, and the installation instructions provided with the equipment. Optional Equipment (e.g.: liquid line solenoid valves, hard start kits, low suction pressure cutout switch kit, high pressure cutout switch kit, refrigerant compressor crankcase heater, etc.) should be installed in strict accordance with the manufacturer's installation instructions.

8. STARTUP AND CHECKOUT

WARNING:

Ensure electrical power to the unit is off prior to performing the following steps. Failure to do so may cause personal injury or death.

Air Filters — Ensure air filters are clean and in place prior to operating the equipment.

Thermostat — Set the room thermostat function switch to OFF, fan switch to AUTO, and move

temperature setpoint to its highest setting. Prior to applying electrical power to the outdoor unit, ensure that the unit has been properly and securely grounded, and that power supply connections have been made at both the facility power interface and outdoor unit.

Outdoor Unit — Ensure the outdoor coil and top of the unit are free from obstructions and debris, and all equipment access/control panels are in place.

Using extreme caution, apply power to the unit and inspect the wiring for evidence of open, shorted, and/or improperly wired circuits.

Functional Checkout:

CAUTION:

If equipped with a compressor crankcase heater, wait 24 hours prior to performing a function checkout to allow for heating of the compressor crankcase. Failure to comply may result in damage and could cause premature failure of the system.

Indoor Blower — Set the thermostat function switch to COOLING and the fan switch to ON. Verify that the indoor blower is operating and that airflow is not restricted. Set the fan switch back to AUTO.

Positive Temperature Coefficient Resistor (PTCR) — (select models) A PTCR is factory installed and located on the control panel of the outdoor unit. The PTCR is a soft start device for use with reciprocating compressors. If a hard start kit is needed on this model the soft start (PTCR) must be removed first.

Low-Pressure Switch — A low-pressure switch is factory-installed in select models only. If provided, this switch is located in the suction line internal to the outdoor unit. The switch is designed to protect the compressor from a loss of charge. Under normal conditions, the switch is closed. If the suction pressure falls below 5 psig, then the switch will open and de-energize the outdoor unit. The switch will close again once the suction pressure increases above 20 psig.

Comfort Alert™ Diagnostics (Select Models)

— The Comfort Alert™ diagnostics is a breakthrough innovation for troubleshooting heat pump and air conditioning system failures. The module installs easily in the electrical box of the outdoor unit near the compressor contactor. By monitoring and analyzing data from the Copeland Scroll compressor® and the thermostat demand, the module can accurately detect the cause of electrical and system related failures without any sensors. A flashing LED indicator communicates the ALERT code and guides the service technician more quickly and accurately to the root cause of a problem.

NOTE: This module does not provide safety protection! The Comfort Alert module is a monitoring device and cannot shut down the compressor directly.

LED Description (See Figure 2)

POWER LED (Green): indicates voltage is present at the power connection of the module.

ALERT LED (Yellow): communicates an abnormal system condition through a unique flash code. The ALERT LED will flash a number of times consecutively, pause and then repeat the process. The number of consecutive flashes, defined as the Flash Code, correlates to a particular abnormal condition. Detailed descriptions of specific ALERT Flash Codes are shown in Table 1 of this manual.

TRIP LED (Red): indicates there is a demand signal from the thermostat but no current to the compressor is detected by the module. The TRIP LED typically indicates the compressor protector is open or may indicate missing supply power to the compressor.

The scroll compressor's run (R), common (C) and start (S) wires are routed through the holes in the Comfort Alert™ module marked "R," "C" and "S." The common (C) wire need not be routed through the module for it to operate properly.

24 VAC Power Wiring — The Comfort Alert™ module requires a constant nominal 24 VAC power supply. The wiring to the module's R and C terminals must be directly from the indoor unit or thermostat. The module cannot be powered by the C terminal on a defrost board or other control board without experiencing nuisance alerts.

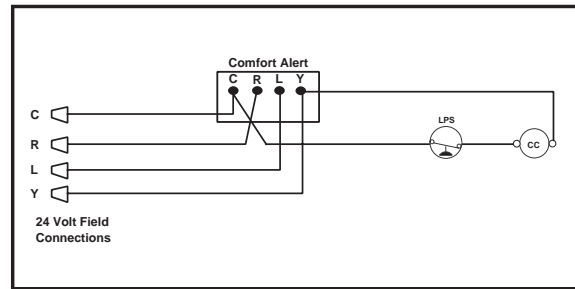

Figure 3. 24VAC Comfort Alert™ Wiring Diagram

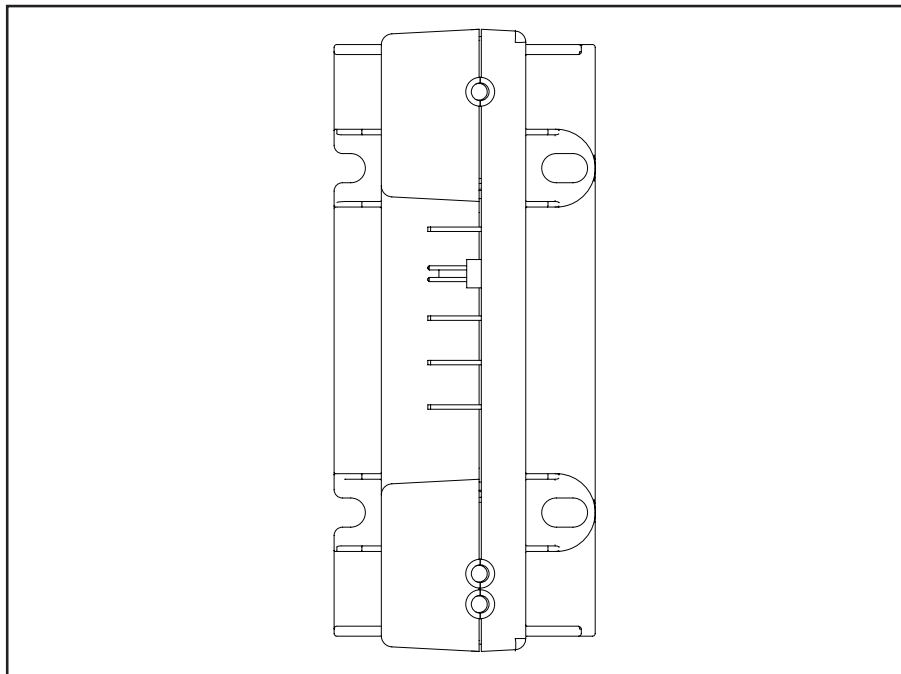

Figure 2. Comfort Alert™ Diagnostics Module

NOTE: Factory installed modules may have different thermostat demand signal wiring, follow manufacturers wiring installations when replacing module.

NOTE: After the thermostat demand signal is connected, verify Y is phased properly with C by measuring 24 VAC across Y and C when demand is present.

TROUBLESHOOTING

Interpreting The Diagnostic LEDs – When an abnormal system condition occurs, the Comfort Alert™ module displays the appropriate ALERT and/or TRIP LED. The yellow alert LED will flash a number of times consecutively, pause and then repeat the process. To identify a Flash Code number, count the number of consecutive flashes. Every time the module powers up, the last ALERT Flash Code that occurred prior to shut down is displayed for one minute.

Cooling — Gradually lower the thermostat temperature setpoint below the actual room temperature and observe that the outdoor unit and indoor blower energize. Feel the air being circulated by the indoor blower and verify that it is cooler than ambient temperature. Listen for any unusual noises. If present, locate and determine the source of the noise and correct as necessary.

Heating — If provided with heating equipment, lower the thermostat setpoint temperature to the lowest obtainable setting and set the thermostat function switch to HEATING. The indoor blower and outdoor unit should stop running. Increase the setpoint temperature of the thermostat to the maximum setting. Verify that the heating equipment has been energized (i.e., fossil fuel burner operating, etc.) and that the indoor blower energizes after a short period of time. Feel the air being circulated by the indoor blower and verify that it is warmer than ambient temperature. Listen for any unusual noises. If present, locate and determine the source of the noise and correct as necessary.

NOTE: Other sources for heating (i.e.: electric furnace, fossil fuel furnace, air handler with electric heat options, etc.) that interface with the unit should be functionally checked to verify

system operation and compatibility. Refer to the installation instructions for this equipment and perform a functional checkout in accordance with the manufacturer's instructions.

Adjustment of Refrigerant Charge:

**CAUTION:**

Split system air conditioner equipment contains liquid and gaseous refrigerant under pressure. Adjustment of refrigerant charge should only be attempted by qualified, trained personnel thoroughly familiar with the equipment. Under no circumstances should the homeowner attempt to install and/or service this equipment. Failure to comply with this warning could result in equipment damage, personal injury, or death.

NOTE: The following Refrigerant Charging Charts are applicable to matched assemblies of our equipment and at listed airflows for the indoor coil. Assemblies of indoor coils and outdoor units not listed are not recommended and deviations from rated airflows or non-listed equipment combinations may require modifications to the expansion device(s) and refrigerant charging procedures for proper and efficient system operation.

Refrigerant Charging Chart — Refer to Refrigerant Charging Charts for correct system charging, and to Orifice Usage Chart for correct restrictor sizes.

NOTE: Linesets over 15 feet in length may require additional refrigerant charge. NORDYNE recommends 0.6 oz. of refrigerant per foot for any lineset over 15 feet.

Optional Equipment — A functional checkout should be performed in accordance with the checkout procedures supplied with the equipment.

Status LED	Status LED Description	Status LED Troubleshooting Information
Green "POWER"	Module has power	Supply voltage is present at module terminals
Red "TRIP"	Thermostat demand signal Y is present, but the compressor is not running	<ol style="list-style-type: none"> 1. Compressor protector is open 2. Outdoor unit power disconnect is open 3. Compressor circuit breaker or fuse(s) is open 4. Broken wire or connector is not making contact 5. Low pressure switch open if present in system 6. Compressor contactor has failed open
Yellow "ALERT" Flash Code 1	Long Run Time Compressor is running extremely long run cycles	<ol style="list-style-type: none"> 1. Low refrigerant charge 2. Evaporator blower is not running 3. Evaporator coil is frozen 4. Faulty metering device 5. Condenser coil is dirty 6. Liquid line restriction (filter drier blocked if present in system) 7. Thermostat is malfunctioning 8. Comfort Alert Failure 9. Comfort Alert Failure
Yellow "ALERT" Flash Code 2	System Pressure Trip Discharge or suction pressure out of limits or compressor overloaded	<ol style="list-style-type: none"> 1. High head pressure 2. Condenser coil poor air circulation (dirty, blocked, damaged) 3. Condenser fan is not running 4. Return air duct has substantial leakage 5. If low pressure switch present in system, check Flash Code 1 information
Yellow "ALERT" Flash Code 3	Short Cycling Compressor is running only briefly	<ol style="list-style-type: none"> 1. Thermostat demand signal is intermittent 2. Time delay relay or control board defective 3. If high pressure switch present go to Flash Code 2 information 4. If low pressure switch present go to Flash Code 1 information
Yellow "ALERT" Flash Code 4	Locked Rotor	<ol style="list-style-type: none"> 1. Run capacitor has failed 2. Low line voltage (contact utility if voltage at disconnect is low) <ul style="list-style-type: none"> • Check wiring connections 3. Excessive liquid refrigerant in compressor 4. Compressor bearings are seized <ul style="list-style-type: none"> • Measure compressor oil level
Yellow "ALERT" Flash Code 5	Open Circuit	<ol style="list-style-type: none"> 1. Outdoor unit power disconnect is open 2. Compressor circuit breaker or fuse(s) is open 3. Compressor contactor has failed open <ul style="list-style-type: none"> • Check compressor contactor wiring and connectors • Check for compressor contactor failure (burned, pitted or open) • Check wiring and connectors between supply and compressor • Check for low pilot voltage at compressor contactor coil 4. High pressure switch is open and requires manual reset 5. Open circuit in compressor supply wiring or connections 6. Unusually long compressor protector reset time due to extreme ambient temperature 7. Compressor windings are damaged <ul style="list-style-type: none"> • Check compressor motor winding resistance
Yellow "ALERT" Flash Code 6	Open Start Circuit Current only in run circuit	<ol style="list-style-type: none"> 1. Run capacitor has failed 2. Open circuit in compressor start wiring or connections <ul style="list-style-type: none"> • Check wiring and connectors between supply and the compressor "S" terminal 3. Compressor start winding is damaged <ul style="list-style-type: none"> • Check compressor motor winding resistance
Yellow "ALERT" Flash Code 7	Open Run Circuit Current only in start circuit	<ol style="list-style-type: none"> 1. Open circuit in compressor run wiring or connections <ul style="list-style-type: none"> • Check wiring and connectors between supply and the compressor "R" terminal 2. Compressor run winding is damaged <ul style="list-style-type: none"> • Check compressor motor winding resistance
Yellow "ALERT" Flash Code 8	Welded Contactor Compressor always runs	<ol style="list-style-type: none"> 1. Compressor contactor has failed closed 2. Thermostat demand signal not connected to module
Yellow "ALERT" Flash Code 9	Low Voltage Control circuit < 17VAC	<ol style="list-style-type: none"> 1. Control circuit transformer is overloaded 2. Low line voltage (contact utility if voltage at disconnect is low) <ul style="list-style-type: none"> • Check wiring connections

- Flash Code number corresponds to a number of LED flashes, followed by a pause and then repeated.
- TRIP and ALERT LEDs flashing at same time means control circuit voltage is too low for operation.

Table 1. Interpreting the Diagnostic LEDs

Miswired Module Indication	Recommended Troubleshooting Action
Green LED is not on, module does not power up	Determine if both R and C module terminals are connected. Verify voltage is present at module's R and C terminals. Review 24VAC Power Wiring (page 4) for R and C wiring.
Green LED intermittent, module powers up only when compressor runs	Determine if R and Y terminals are wired in reverse. Verify module's R and C terminals have a constant source. Review 24VAC Power Wiring (page 4) for R and C wiring.
TRIP LED is on but system and compressor check OK	Verify Y terminal is connected to 24VAC at contactor coil. Verify voltage at contactor coil falls below 0.5VAC when off.
TRIP LED and ALERT LED flashing together	Verify R and C terminals are supplied with 19-28VAC.
ALERT Flash Code 3 (Compressor Short Cycling) displayed incorrectly	Verify Y terminal is connected to 24VAC at contactor coil. Verify voltage at contactor coil falls below 0.5VAC when off.
ALERT Flash Code 5, 6 or 7 (Open Circuit, Open Start Circuit or Open Run Circuit) displayed incorrectly	Check that compressor run and start wires are through module's current sensing holes. Verify Y terminal is connected to 24VAC at contactor coil. Verify voltage at contactor coil falls below 0.5VAC when off.
ALERT Flash Code 6 (Open Start Circuit) displayed for Code 7 (Open Run Circuit) or vice versa	Check that compressor run and start wires are routed through the correct module sensing holes.
ALERT Flash Code 8 (Welded Contactor) displayed incorrectly	Determine if module's Y terminal is connected. Verify Y terminal is connected to 24VAC at contactor coil. Verify 24VAC is present across Y and C when thermostat demand signal is present. If not, R and C are reverse wired. Verify voltage at contactor coil falls below 0.5VAC when off.

Table 2. Module Wiring Troubleshooting

**Refrigerant Metering Device
for 13 SEER Split System Air Conditioner
with ZRKA Compressor**

Model Number	Restrictor Bore Size (inches)	System Charge R-22 (oz.)
1.5 ton	0.050	74
2.0 ton	0.059	98
2.5 ton	0.067	116
3.0 ton	0.075	116
3.5 ton	0.080	170
4.0 ton	0.089	147
5.0 ton	0.099	232

**Refrigerant Metering Device
for 13 SEER Split System Air Conditioner
with CRK7 Compressor**

Model Number	Restrictor Bore Size (inches)	System Charge R-22 (oz.)
2.0 ton	0.060	104
2.5 ton	0.067	131
3.0 ton	0.075	136

Restrictor Refrigerant Charging Charts Legend For Cooling Mode of Operation

*Note all pressures are listed in psig. and all temperatures in deg. °F.



- Shaded Boxes indicate flooded conditions



- Rated Design Values. Suction Pressure will be lower than design value if indoor air flow, entering dry bulb, or entering wet bulb temperatures are lower than design.

- Discharge temperatures greater than charted values indicates a refrigerant undercharge.

Restrictor Refrigerant Charging Charts with ZRKA Compressors

1-1/2 TON	OUTDOOR TEMPERATURE (°F)															
	70		75		80		85		90		95		100		105	
Suc. Press.	Dis. Press.	Dis. Temp.	Dis. Press.	Dis. Temp.	Dis. Press.	Dis. Temp.	Dis. Press.	Dis. Temp.	Dis. Press.	Dis. Temp.	Dis. Press.	Dis. Temp.	Dis. Press.	Dis. Temp.	Dis. Press.	Dis. Temp.
72	170	135														
74	172	141	186	140												
76	174	146	188	145	202	145										
78	177	150	190	150	204	149	219	149								
80	180	153	193	154	207	154	221	154	235	154						
82			197	157	210	158	223	158	237	158	251	158				
84					213	162	226	162	239	162	253	162	268	162		
86							229	166	242	166	255	167	270	166	284	167
88							233	170	246	170	259	171	272	170	286	171
90									249	174	262	175	275	175	288	174
92											266	179	279	179	292	179
94													282	183	295	183
96															298	188
98																

2 TON	OUTDOOR TEMPERATURE (°F)															
	70		75		80		85		90		95		100		105	
Suc. Press.	Dis. Press.	Dis. Temp.	Dis. Press.	Dis. Temp.	Dis. Press.	Dis. Temp.	Dis. Press.	Dis. Temp.	Dis. Press.	Dis. Temp.	Dis. Press.	Dis. Temp.	Dis. Press.	Dis. Temp.	Dis. Press.	Dis. Temp.
71	150	138														
73	152	143	166	142												
75	155	149	169	147	183	145										
77	157	154	171	152	185	150	199	148								
79	160	157	173	157	187	155	201	153	215	152						
81			177	160	189	159	203	158	217	156	231	155				
83					193	162	206	162	219	160	233	159	247	158		
85							209	165	222	164	235	163	249	162	263	160
87							213	169	226	168	239	167	251	166	265	164
89									229	172	242	171	255	170	267	168
91											245	175	258	174	271	173
93													262	178	275	177
95															278	182
97																

Restrictor Refrigerant Charging Charts with ZRKA Compressors Continued

2-1/2 TON		OUTDOOR TEMPERATURE (°F)															
		70		75		80		85		90		95		100		105	
Suc. Press.	Dis. Press.	Dis. Temp.	Dis. Press.	Dis. Temp.	Dis. Press.	Dis. Temp.	Dis. Press.	Dis. Temp.	Dis. Press.	Dis. Temp.	Dis. Press.	Dis. Temp.	Dis. Press.	Dis. Temp.	Dis. Press.	Dis. Temp.	
71	149	131															
73	151	136	164	135													
75	154	142	167	140	180	139											
77	157	144	169	145	182	144	195	143									
79	161	147	172	148	184	148	197	147	210	146							
81			176	151	188	152	199	152	212	151	226	150					
83					191	155	203	155	215	155	228	154	241	154			
85							206	159	218	159	230	159	243	158	256	158	
87							210	163	221	163	233	163	245	162	258	161	
89									225	167	237	167	248	166	260	165	
91											240	171	252	170	264	170	
93													255	175	267	174	
95															270	179	
97																	

3 TON		OUTDOOR TEMPERATURE (°F)															
		70		75		80		85		90		95		100		105	
Suc. Press.	Dis. Press.	Dis. Temp.	Dis. Press.	Dis. Temp.	Dis. Press.	Dis. Temp.	Dis. Press.	Dis. Temp.	Dis. Press.	Dis. Temp.	Dis. Press.	Dis. Temp.	Dis. Press.	Dis. Temp.	Dis. Press.	Dis. Temp.	
67	149	137															
69	151	142	164	142													
71	153	147	167	147	180	146											
73	156	151	169	152	182	151	196	150									
75	160	154	172	155	185	156	198	155	212	155							
77			175	158	188	159	200	160	214	159	227	159					
79					191	163	203	163	216	164	229	163	243	164			
81							207	167	219	168	231	168	245	168	259	168	
83							210	171	223	171	235	172	247	172	261	172	
85									226	175	238	176	251	176	263	175	
87											242	180	254	180	266	180	
89													257	184	270	184	
91															273	189	
93																	

3-1/2 TON		OUTDOOR TEMPERATURE (°F)															
		70		75		80		85		90		95		100		105	
Suc. Press.	Dis. Press.	Dis. Temp.	Dis. Press.	Dis. Temp.	Dis. Press.	Dis. Temp.	Dis. Press.	Dis. Temp.	Dis. Press.	Dis. Temp.	Dis. Press.	Dis. Temp.	Dis. Press.	Dis. Temp.	Dis. Press.	Dis. Temp.	
72	150	143															
74	152	148	166	145													
76	154	153	168	150	181	148											
78	158	157	170	155	183	153	197	150									
80	161	160	173	159	185	157	199	155	212	152							
82			177	162	189	161	201	159	214	157	228	155					
84					192	164	204	163	216	161	230	159	243	157			
86							208	167	220	165	232	163	245	161	259	159	
88							211	170	223	169	235	167	248	165	261	163	
90									227	173	239	171	251	169	263	166	
92											242	175	254	173	267	171	
94													258	178	270	175	
96															273	180	
98																	

Restrictor Refrigerant Charging Charts with ZRKA Compressors Continued

4 TON		OUTDOOR TEMPERATURE (°F)															
		70		75		80		85		90		95		100		105	
Suc. Press.	Dis. Press.	Dis. Temp.	Dis. Press.	Dis. Temp.	Dis. Press.	Dis. Temp.	Dis. Press.	Dis. Temp.	Dis. Press.	Dis. Temp.	Dis. Press.	Dis. Temp.	Dis. Press.	Dis. Temp.	Dis. Press.	Dis. Temp.	
69	145	136															
71	147	141	161	140													
73	149	146	163	145	177	144											
75	152	152	165	150	179	149	193	148									
77	155	154	168	155	181	154	195	153	209	152							
79			171	158	184	158	197	158	211	157	225	156					
81					187	162	200	162	213	161	227	160	241	160			
83							204	165	216	165	229	165	243	164	257	164	
85							207	169	220	169	233	169	245	168	259	167	
87									223	173	236	173	249	172	261	171	
89											239	177	252	177	265	176	
91													256	181	268	180	
93															272	185	
95																	

5 TON		OUTDOOR TEMPERATURE (°F)															
		70		75		80		85		90		95		100		105	
Suc. Press.	Dis. Press.	Dis. Temp.	Dis. Press.	Dis. Temp.	Dis. Press.	Dis. Temp.	Dis. Press.	Dis. Temp.	Dis. Press.	Dis. Temp.	Dis. Press.	Dis. Temp.	Dis. Press.	Dis. Temp.	Dis. Press.	Dis. Temp.	
66	151	144															
68	153	149	167	149													
70	156	155	170	154	184	154											
72	158	160	172	159	186	159	200	158									
74	161	162	174	164	188	163	202	163	216	163							
76			178	167	191	168	204	168	218	167	232	167					
78					194	171	207	172	220	172	234	172	248	172			
80							210	175	223	176	236	176	250	176	264	176	
82							214	179	227	180	240	180	252	180	266	180	
84									230	183	243	184	256	184	268	184	
86											246	188	259	188	272	188	
88													263	193	276	193	
90															279	197	
92																	

Restrictor Refrigerant Charging Charts with CRK7 Compressors

2 TON		OUTDOOR TEMPERATURE (°F)															
		70		75		80		85		90		95		100		105	
Suction Press.	Dis. Press.	Dis. Temp.	Dis. Press.	Dis. Temp.	Dis. Press.	Dis. Temp.	Dis. Press.	Dis. Temp.	Dis. Press.	Dis. Temp.	Dis. Press.	Dis. Temp.	Dis. Press.	Dis. Temp.	Dis. Press.	Dis. Temp.	
73	154	149															
75	156	154	168	149													
77	158	159	171	154	183	149											
79	163	160	173	159	185	154	198	150									
81	167	162	177	161	187	159	200	154	212	150							
83			181	164	192	162	202	159	214	155	227	151					
85					195	165	206	162	216	159	229	155	241	151			
87							209	166	220	163	231	159	243	155	256	152	
89							213	169	224	167	234	163	245	159	258	156	
91									227	171	238	167	249	164	260	160	
93											241	171	252	168	263	164	
95													255	172	266	168	
97															270	173	
99																	

Restrictor Refrigerant Charging Charts with CRK7 Compressors Continued

2-1/2 TON	OUTDOOR TEMPERATURE (°F)															
	70		75		80		85		90		95		100		105	
Suction Press.	Dis. Press.	Dis. Temp.	Dis. Press.	Dis. Temp.	Dis. Press.	Dis. Temp.	Dis. Press.	Dis. Temp.	Dis. Press.	Dis. Temp.	Dis. Press.	Dis. Temp.	Dis. Press.	Dis. Temp.	Dis. Press.	Dis. Temp.
73	146	142														
75	148	148	160	144												
77	150	153	162	149	174	145										
79	155	155	164	154	176	150	188	146								
81	158	157	168	156	178	154	190	150	202	147						
83			172	159	182	157	192	155	204	151	216	148				
85					186	161	196	159	206	156	218	153	230	150		
87							200	162	210	160	220	157	232	154	244	151
89							203	166	213	164	224	161	234	158	246	155
91									217	167	227	165	238	162	248	158
93											231	169	241	166	252	163
95													245	170	255	167
97															258	172
99																

3 TON	OUTDOOR TEMPERATURE (°F)															
	70		75		80		85		90		95		100		105	
Suction Press.	Dis. Press.	Dis. Temp.	Dis. Press.	Dis. Temp.	Dis. Press.	Dis. Temp.	Dis. Press.	Dis. Temp.	Dis. Press.	Dis. Temp.	Dis. Press.	Dis. Temp.	Dis. Press.	Dis. Temp.	Dis. Press.	Dis. Temp.
70	150	155														
72	152	161	164	155												
74	154	166	166	160	178	155										
76	159	166	168	165	180	160	192	155								
78	163	169	173	167	182	165	194	159	206	155						
80			176	170	187	167	197	164	209	159	221	155				
82					190	170	201	167	211	164	223	159	235	155		
84							204	171	214	167	225	163	237	159	249	155
86							207	175	218	171	228	167	239	163	251	159
88									221	175	232	172	242	167	253	163
90											235	176	246	172	256	167
92													249	176	259	172
94															263	176
96																

TXV Refrigerant Charging Charts with ZRKA Compressors

1.5 Ton AC TXV Charging Chart

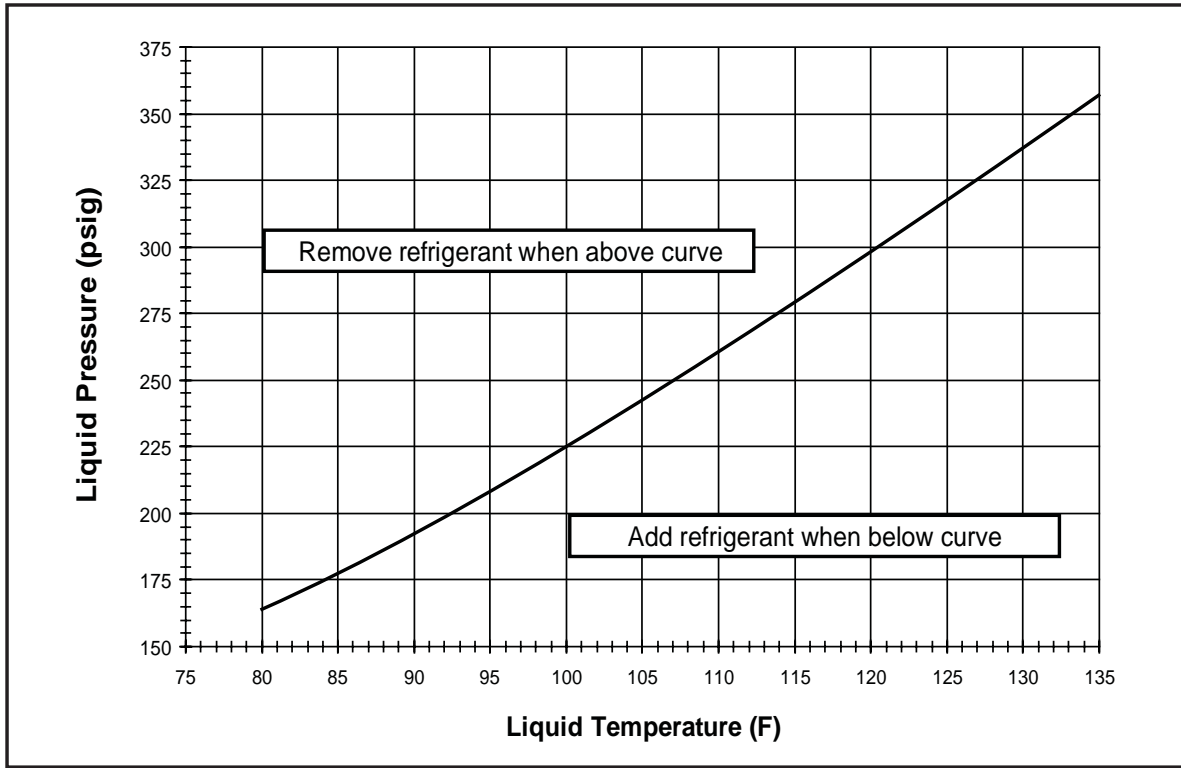

2.0 Ton AC TXV Charging Chart

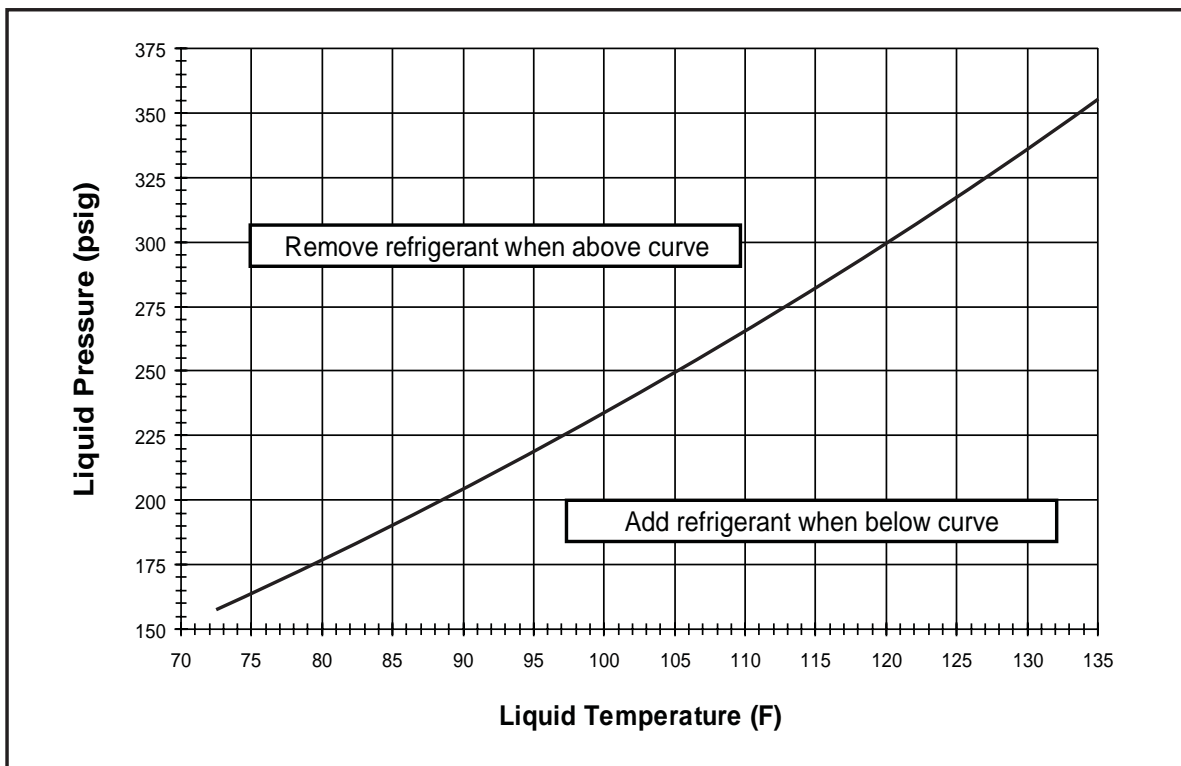

TXV Refrigerant Charging Charts with ZRKA Compressors Continued

2.5 Ton AC TXV Charging Chart

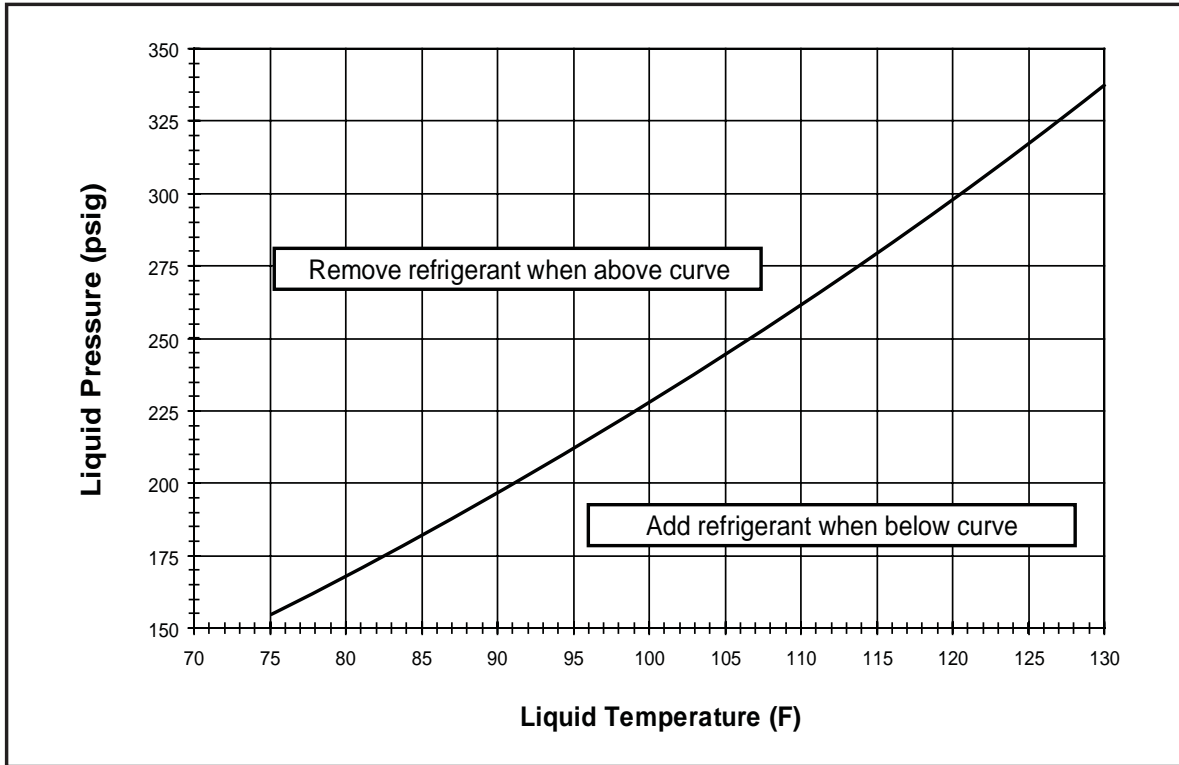

3.0 Ton AC TXV Charging Chart

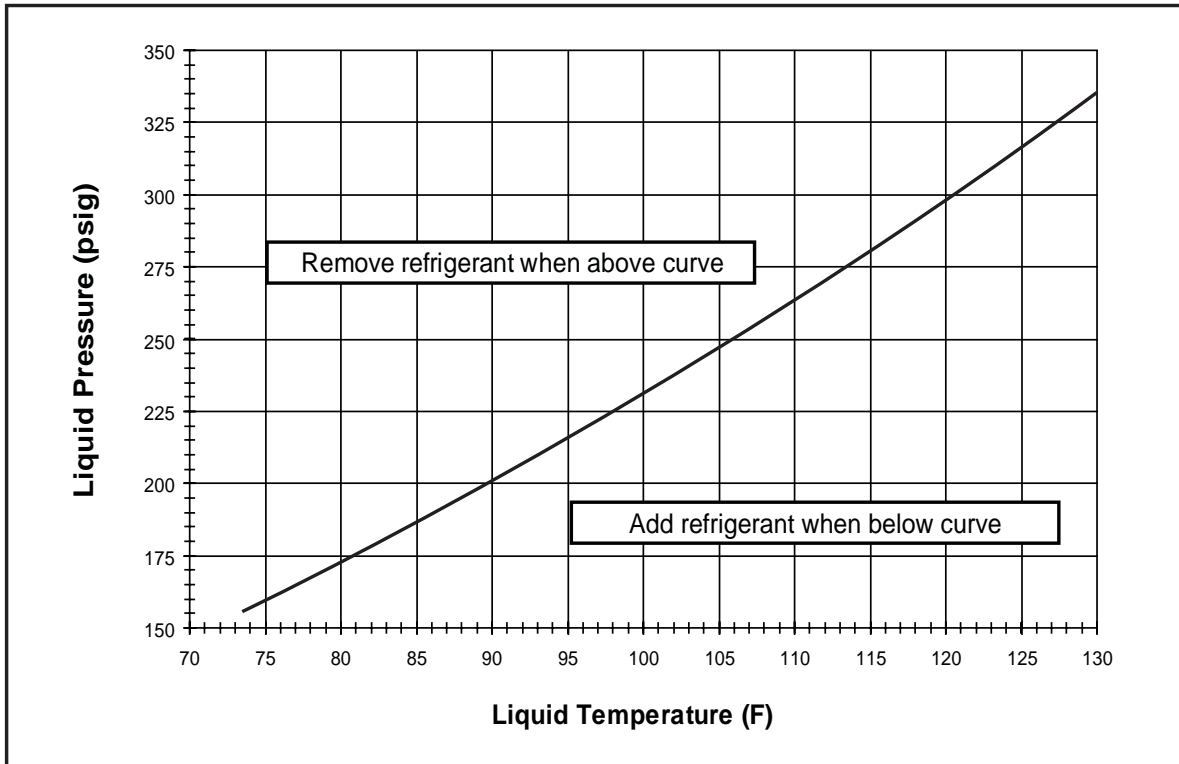

TXV Refrigerant Charging Charts with ZRKA Compressors Continued

3.5 Ton AC TXV Charging Chart

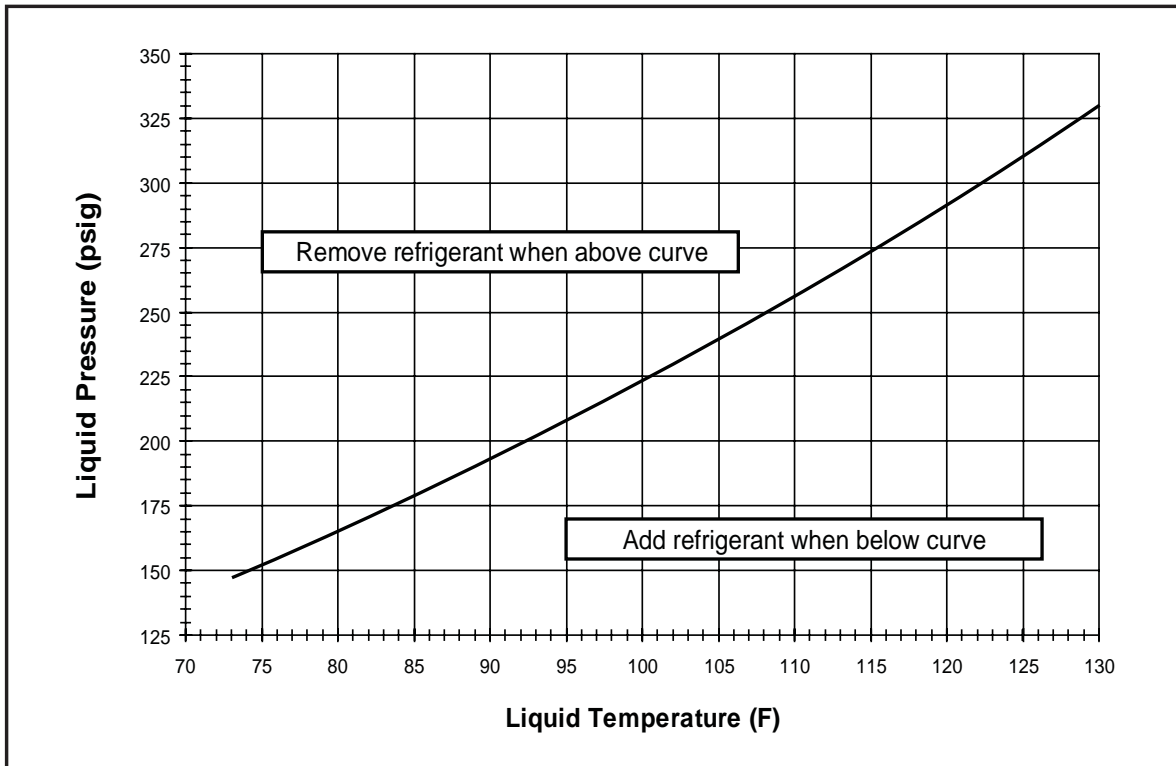

4.0 Ton AC TXV Charging Chart

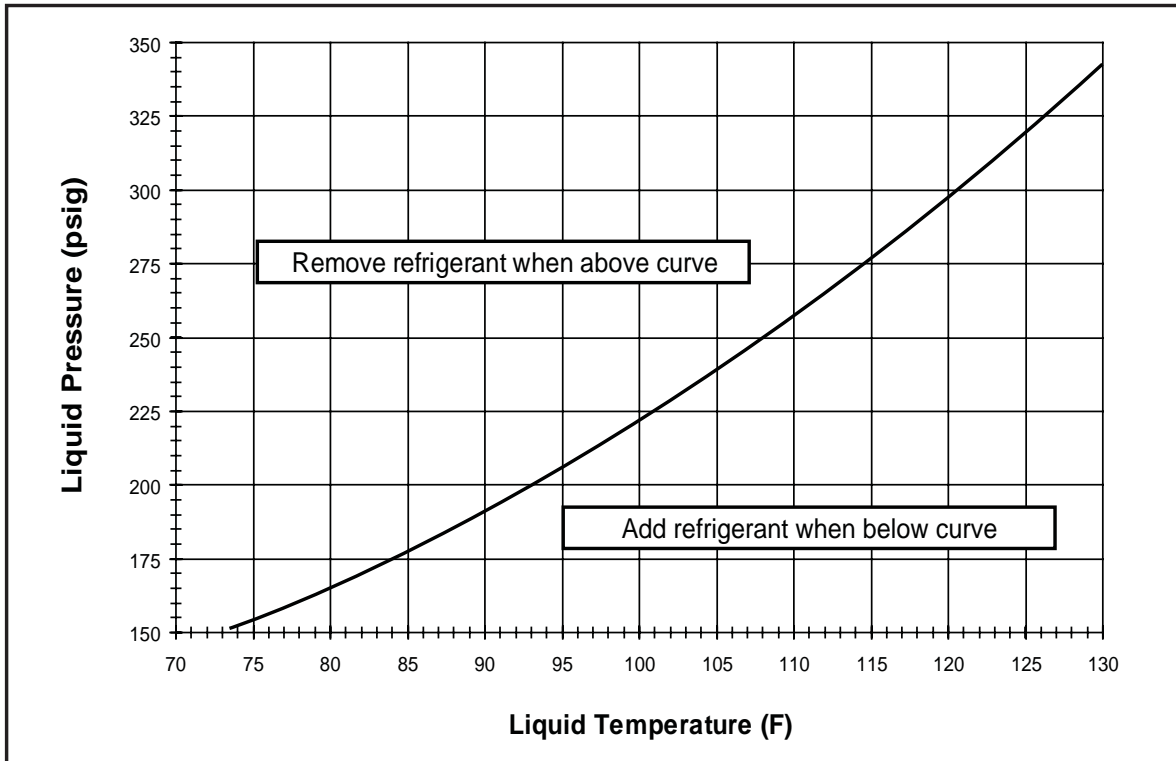

TXV Refrigerant Charging Charts with ZRKA Compressors Continued

5.0 Ton AC TXV Charging Chart

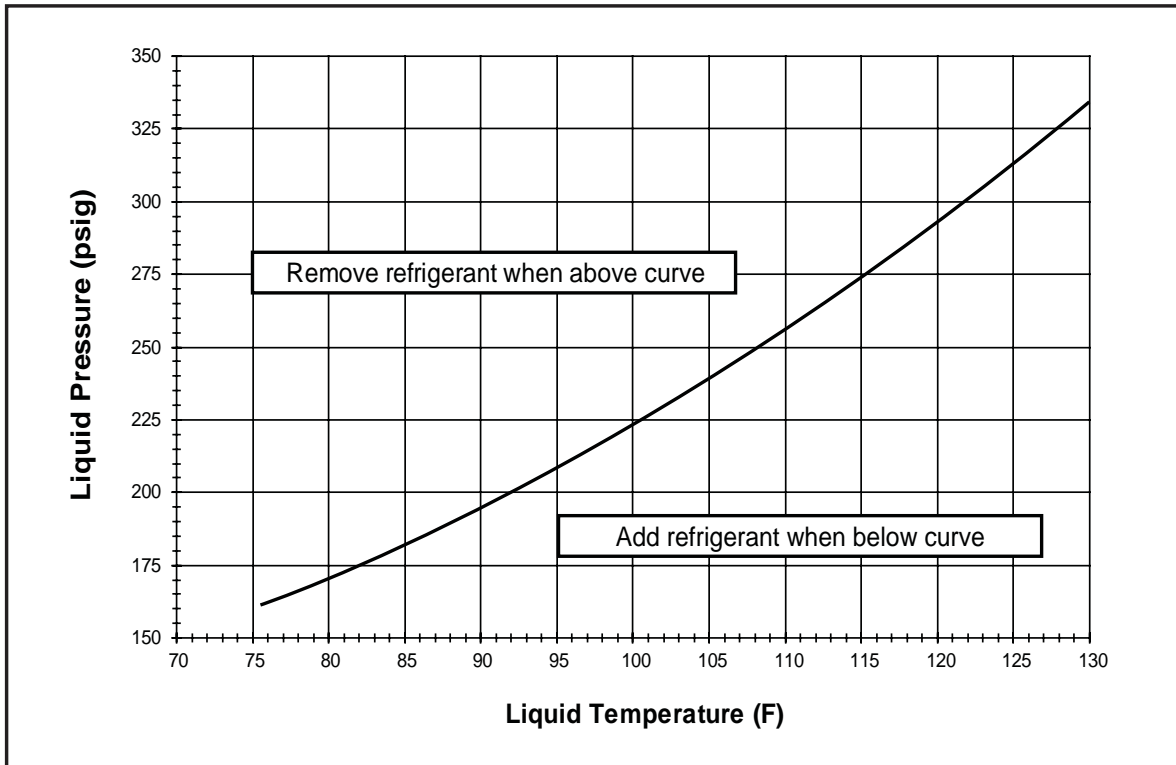

TXV Refrigerant Charging Charts with CRK7 Compressors

2.0 Ton AC CRK7 TXV Charging Chart

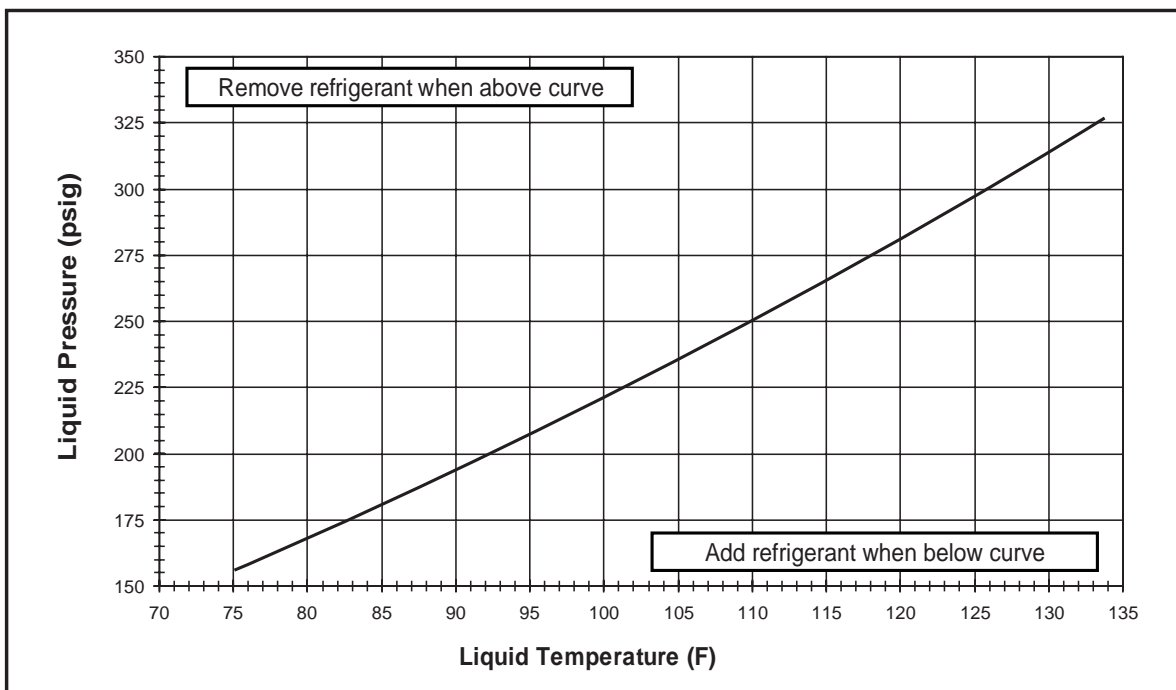

TXV Refrigerant Charging Charts with CRK7 Compressors Continued

2.5 Ton AC CRK7 TXV Charging Chart

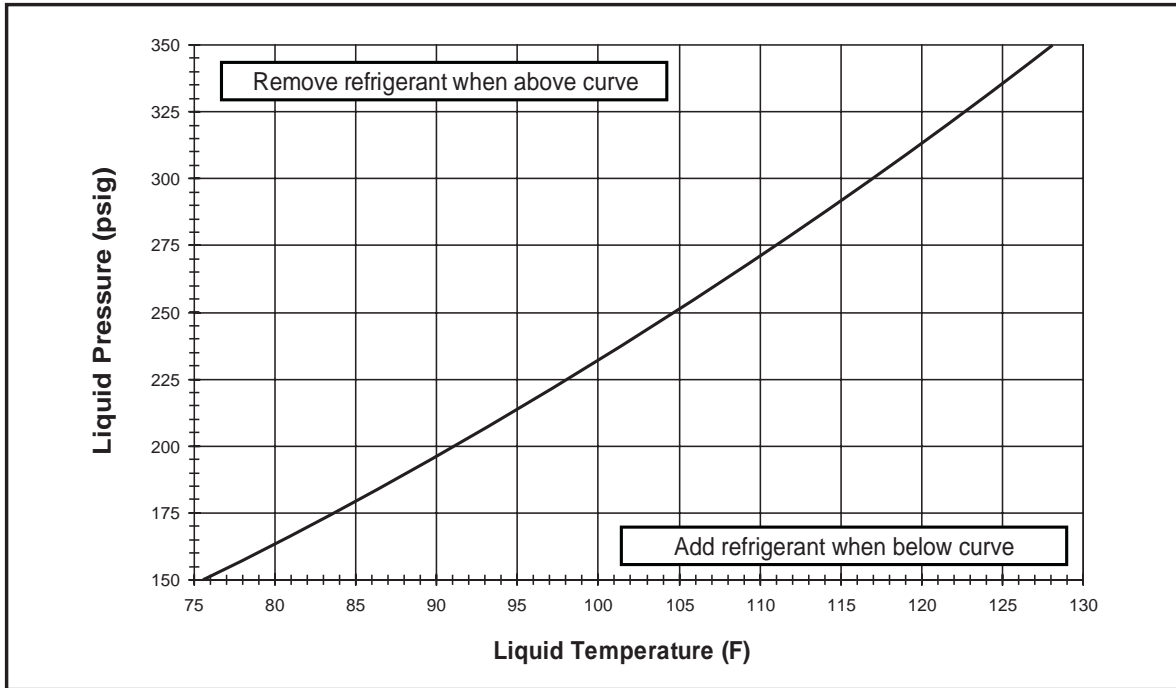

3.0 Ton AC CRK7 TXV Charging Chart

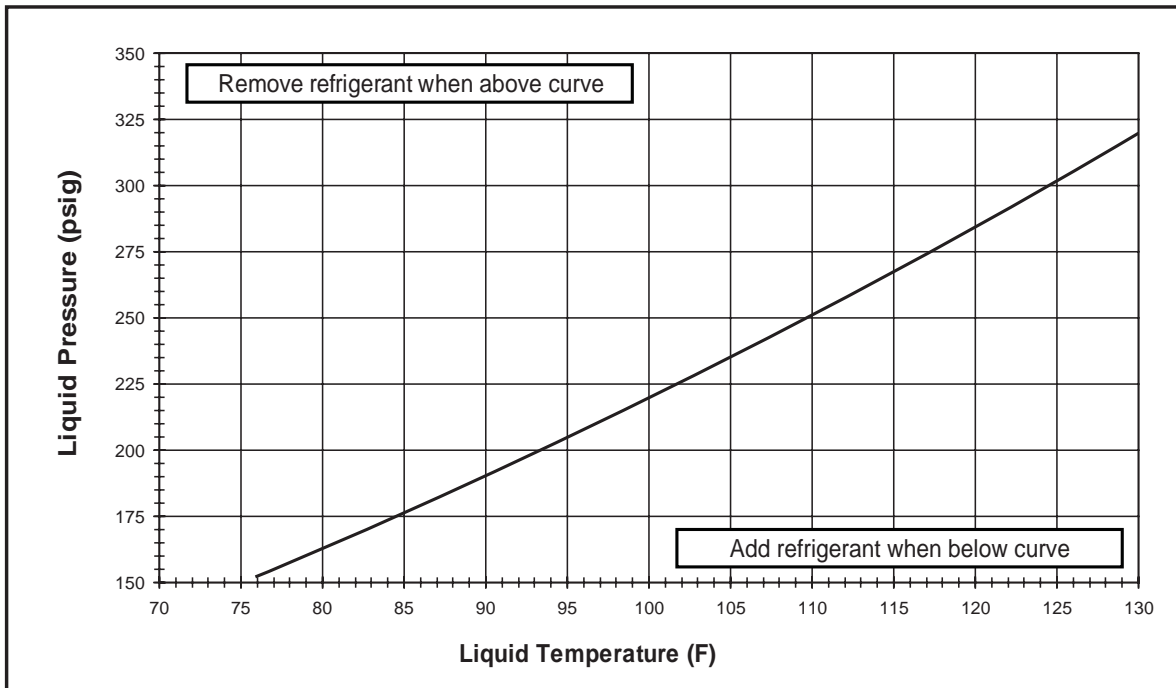



**INSTALLER: PLEASE LEAVE
THESE INSTALLATION INSTRUCTIONS
WITH THE HOMEOWNER.**



708451A

708451A (Replaces 7084510)
Specifications and illustrations subject to change
without notice and without incurring obligations.
Printed in U.S.A. (01/06)