

Installation Instructions

Indoor Air Handlers

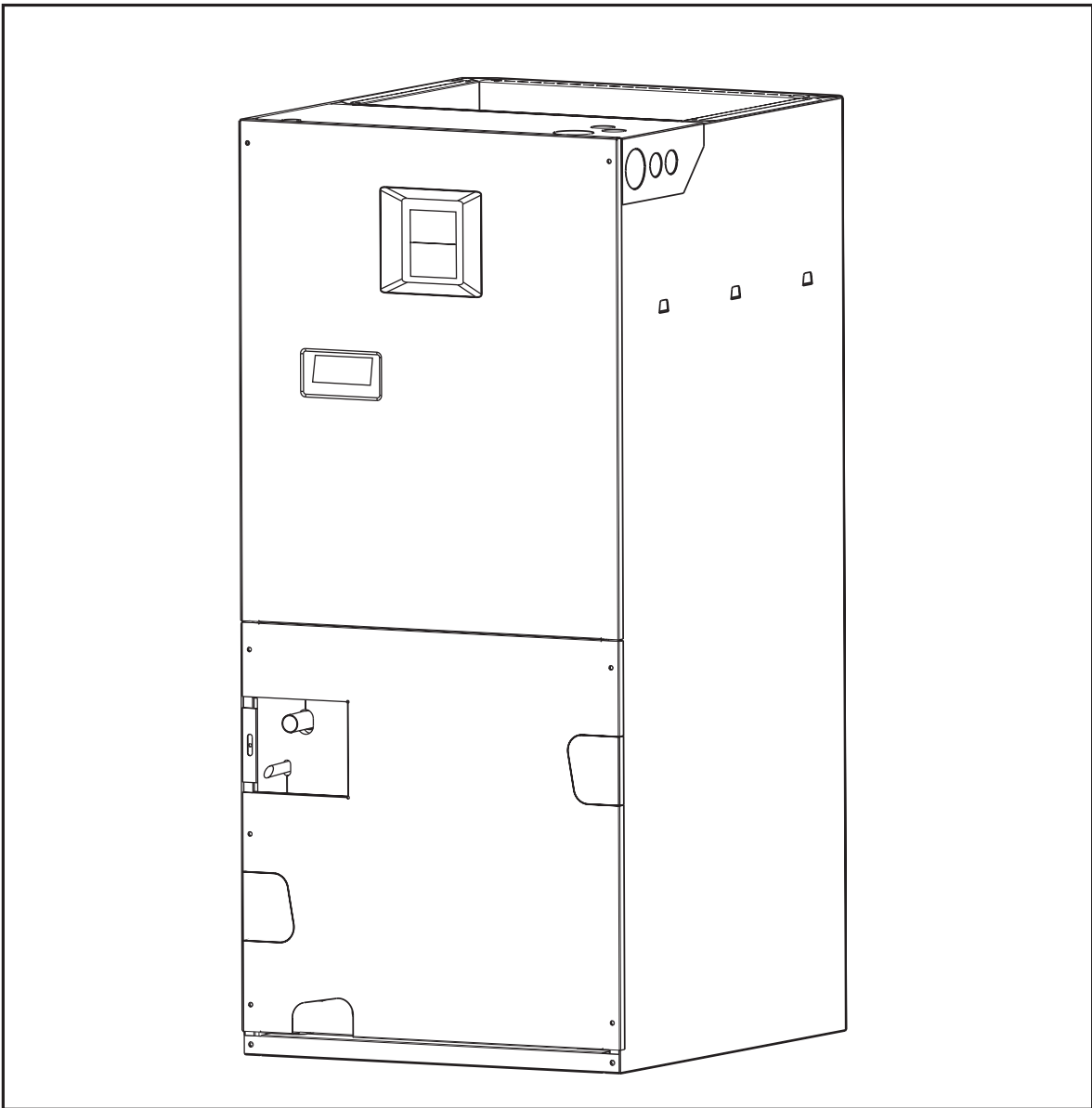

These instructions are primarily intended to assist qualified individuals experienced in the proper installation of heating and/or air conditioning appliances. Some local codes require licensed installation/service personnel for this type equipment. All installations must be in accordance with these instructions and with all applicable national and local codes and standards.

Before beginning the installation, read these instructions thoroughly and follow all warnings and cautions in the instructions and on the unit. When performing brazing operations have a fire extinguisher readily available and use a quenching cloth and brazing shield.

Improper installation, service, adjustment, or maintenance can cause fire, electrical shock or other conditions which may result in personal injury or property damage. Unless otherwise noted in these instructions, only factory authorized kits or accessories may be used when modifying this product.

1. AIR HANDLER SPECIFICATIONS

Indoor Air Handlers are designed and approved for attic, basement, alcove, closet and crawl space installations.

Factory ready horizontal Air Handlers may be applied in upflow or horizontal-left and -right discharge applications. These units may also be applied in downflow discharge when applied with the appropriate field kit (See Technical Specifications).

Vertical only Air Handlers are factory ready for upflow applications. These units may be applied in downflow or horizontal left and right discharge applications when applied with the appropriate field kit (See Technical Specifications).

Dimensional drawing for the unit is shown in Figure 1.

Field-installed electric heater kits are available. Available heater kits for these units are listed

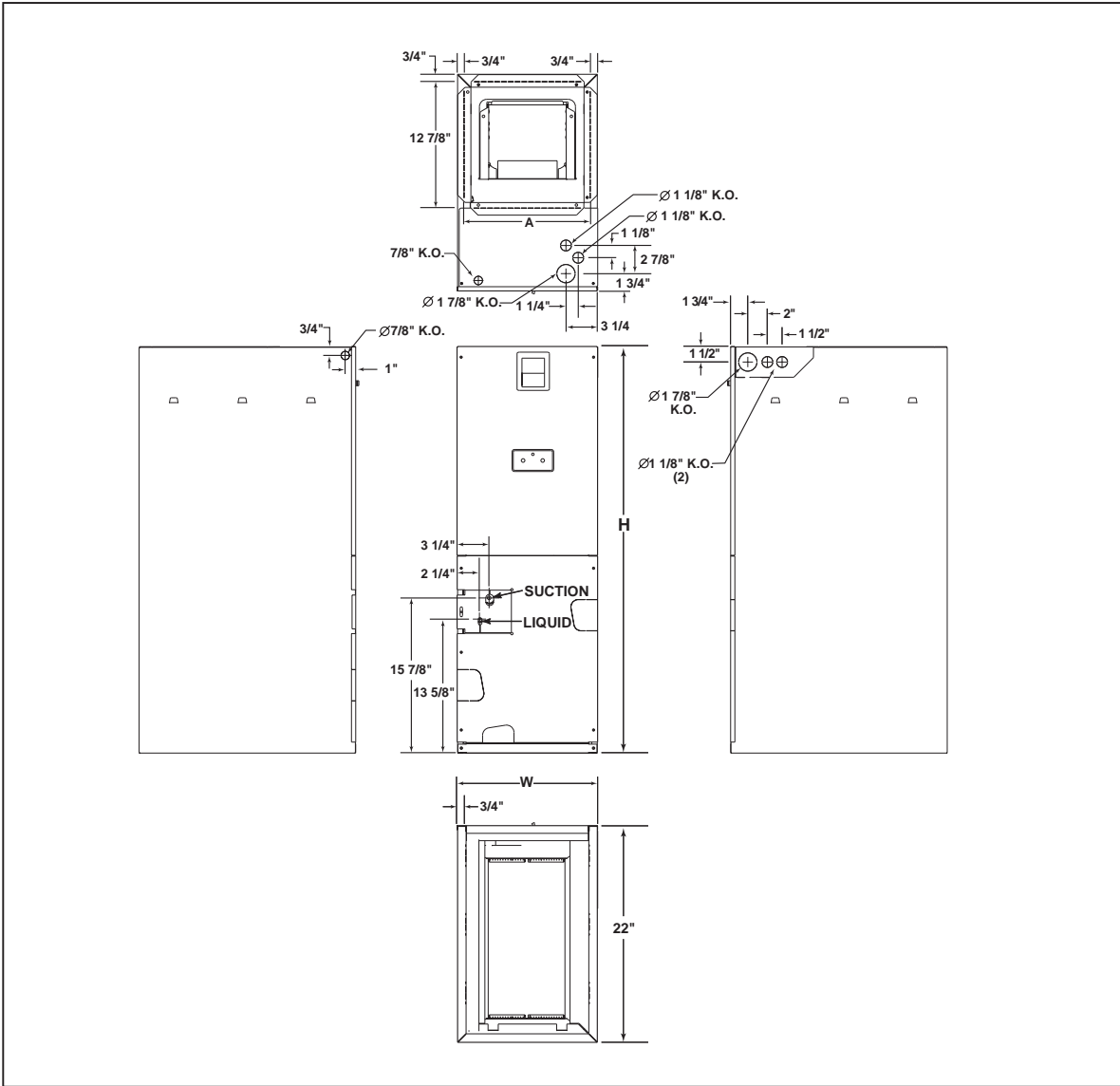

Cabinet Size	H	W	A
A	41-5/16	14-3/16	12-3/4
B	43-5/16	19-11/16	18-1/4
C	43-5/16	22-7/16	21
Tall C	53-5/16	22-7/16	21

Figure 1. Unit Dimensions

in the Technical Specifications. Instructions for installing the electric heaters are included with the heaters.

"B" and "C" cabinet units equipped with standard blowers may be upgraded to variable speed with the addition of a variable speed conversion kit. See Technical Specifications for details.

Air handlers set up with 15 kw or more of electric heat will normally be configured for dual-circuit power supply. They may, however, be connected to a single-circuit power supply with the addition of the single circuit accessory kit (See Technical Specifications). Select the wire size and over-current protection in accordance with the minimum circuit ampacity and maximum over-current protection shown in Table 1.

2. INSTALLATION REQUIREMENTS

Check Equipment — All installations shall be made as described in these installation instructions and in accordance with all applicable national and local codes including the requirements of local utilities.

Requirements and Codes — Electrical power wiring must be made in accordance with all applicable local codes and ordinances, and with the current revision of the National Electric Code (ANSI/NFPA 70). Air ducts must be installed in accordance with the standards of the National Fire Protection Association “Standard for Installation of Air Conditioning and Ventilation Systems” (NFPA 90A), “Standard for Installation of Residence Type Warm Air Heating and Air Conditioning Systems” (NFPA 90B), these instructions, and all applicable local codes.

NFPA publications are available from:

National Fire Protection Association, Inc.
 Batterymarch Park
 Quincy, Maine 02269
 www.nfpa.org
 (617) 770-3000

Location — To insure proper condensate drainage, the unit must be installed in a level position within 1/4 inch over the height, width, and depth of the unit. The best system performance will be obtained if the unit is located in a centralized position with respect to the air distribution system.

These wiring requirements are for units with optional heater kits. They can not be used with 115 volt units.

Aux. Heat Installed (Nom. KW)	Single Circuit			Dual Circuit								
	Min*** Circuit Amp.	Wire AWG 75°C*	Max. Over-current	Circuit A				Circuit B				
				Min*** Circuit Amp.	Wire AWG 60°C*	Wire AWG 75°C*	Max. Over-current	Min*** Circuit Amp.	Wire AWG 60°C*	Wire AWG 75°C*	Max. Over-current	
240 VAC, 60 & 50 Hz Single Phase	none	5.0	14	15	5.0	14	14	15	-	-	-	-
	5	30.0	10	30	30.0	10	10	30	-	-	-	-
	8	44.1	8	50	44.1	6	8	50	-	-	-	-
	10	55.0	6	60	55.0	6	6	60	-	-	-	-
	14	74.8	4	80	39.9	8	8	40	34.9	8	8	35
	15	80.0	4	90	55.0	6	6	60	25.0	10	12	30
	20	105.0	2	125	55.0	6	6	60	50.0	4	8	50
208 VAC, 60 Hz Single Phase	none	5.0	14	15	5.0	14	14	15	-	-	-	-
	5	26.6	10	30	26.6	10	10	30	-	-	-	-
	8	38.8	8 (6**)	40	38.8	8	8 (6**)	40	-	-	-	-
	10	48.3	8	50	48.3	6	8	50	-	-	-	-
	14	65.5	4	70	35.0	8	8	35	30	10	10	30
	15	69.9	4	70	48.3	6	8	50	21.6	10	12	25
	20	91.5	3	100	48.3	6	8	50	43.3	6	8	50

* All wire sizes for copper conductors only, based on NEC Table 310-16

**Required for C-cabinet variable speed.

***Circuit ampacity slightly higher for variable speed. See label on blower.

Table 1. Minimum Ampacity and Maximum Overcurrent Protection

When an air handler is installed over a finished ceiling and/or living space, the installation of a secondary drain pan under the entire unit is required to reduce the possibility of property damage.

All servicing and cleaning of the air handler can be done from the front. Adequate horizontal clearances should be provided to allow for service and care of the unit. A minimum 24 inch clearance at the front of the unit is recommended. These units are suitable for attic, closet, crawl space or alcove installation at zero clearance from combustibles.

Location of the Room Thermostat — The room thermostat should be mounted 4 to 5 feet above the floor, on an inside wall that has good air circulation from all areas being controlled by the thermostat. For optimum performance, it is essential that there be free circulation of air at the thermostat location. Air movement should not be obstructed by furniture, doors, draperies, etc. The thermostat should not be mounted where it will be affected by drafts, hot or cold water pipes or air ducts in walls, radiant heat from a fireplace, lamps, the sun, a TV, etc. Consult the instruction sheet packed with the thermostat for mounting instructions.

Condensate Drain — The condensate pan has primary and secondary drain connections. The connections have 3/4 inch female pipe threads. All condensate drains should be a minimum of 7/8 inch OD copper or plastic tubing or 3/4 inch galvanized iron pipe. The drain should be pitched downward at a slope of 1 inch to 10 feet.

If the air handler is located in or above a living space where damage may result from condensate overflow, a separate 3/4 inch drain must be provided from the secondary drain connection and a secondary drain pan with a secondary drain line must be installed under the entire unit. Run secondary drains to a place where water running from them will be noticed.

Install a 5 inch trap in the condensate drain line as close to the coil as possible. Make sure that the top of the trap is below the bottom of the drain pan to prevent the condensate from overflowing the drain pan. Prime the trap with water. Insulate the drain if it is located in an unconditioned space, and test the condensate line for leaks. Consult local codes for additional restrictions or precautions.

NOTE: There must be only one trap in the drain line. Using more than one trap may prevent drainage.



IMPORTANT:

The plastic drain pan must be level or slightly sloped toward the drain lines.

3. AIR DUCTS, FILTERS, HORIZONTAL APPLICATIONS

Air ducts should be installed in accordance with the standards of the National Fire Protection Association “Standard for Installation of Air Conditioning and Ventilation Systems” (NFPA 90A), “Standard for Installation of Residence Type Warm Air Heating and Air Conditioning Systems” (NFPA 90B), these instructions, and all applicable local codes.

Use transition fittings if the supply and/or return air openings of the unit do not match the duct openings. These transitions should be dimensioned in accordance with standard practice as specified in the ASHRAE recommendations for duct transitions.

Flexible connectors should be used between the unit and the ductwork to prevent transmission of vibration from the unit to the structure. If electric heater kits are installed, heat resistant material must be used for the flexible connector at the supply air end of the unit.

Air Filter Installation — The filter may be located in the return air duct system or installed into the air handler filter track located in the bottom of the unit.

To install the filter, remove the filter door. The filter sizes for the air handler cabinets are:

Cabinet	Filter
A	12 x 20 x 1
B	18 x 20 x 1
C	20 x 20 x 1

! WARNING:

Never operate the unit without a filter or with the doors removed. Dust and lint in the return air can build up on internal components, resulting in a loss of efficiency, equipment damage, and possible fire risk.

Upflow Applications — All air handlers are factory shipped, ready for upflow configuration, all return air must enter from the bottom of the unit. A typical installation of the unit in a ducted return air mode is shown in Figure 2.

Downflow Applications — The downflow accessory kit (See Technical Specifications) is required for downflow applications. Instructions for installing the downflow accessory kit are included with the kit. It is recommended that the accessory be installed prior to installing the unit. All return air in downflow applications must enter through the top of the unit. A typical installation of the unit in a downflow application is shown in Figure 3.

NOTE: For 066 models, see addendum sheet when installing in horizontal, left or right.

Horizontal Left And Horizontal Right — Air handlers may or may not be shipped from the factory with all the parts required for horizontal left applications and horizontal right applications (see Figure 5). If your unit does not have parts for a horizontal application, a kit is available (see Technical Specifications).

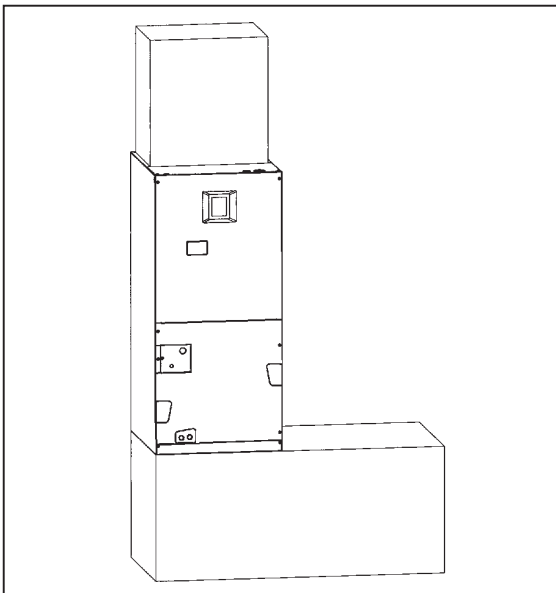

Figure 2. Upflow Installation

To Configure Unit for Horizontal LEFT Installations:

- 1) Remove the coil access door.
- 2) Remove the front drain pan support bracket (if supplied).
- 3) Slide the coil and drain pan assembly out of the unit.
- 4) **IMPORTANT:** Remove the plug from one of the threaded holes in the horizontal drain pan. Completely remove the webbing located in the threaded holes of the horizontal drain pan. If webbing is not removed, the drain will not function properly and ceiling damage may occur.
- 5) Insert a plug (from the horizontal drain pan) into the open and unused drain hole in the drain pan at the bottom of the unit to block bypass air.
- 6) Remove the corresponding drain line knockout from the coil access door to allow access to the horizontal drain.
- 7) Replace the door and attach the drain line.

To Configure Unit for Horizontal RIGHT Installations:

- 1) Remove the coil access door. Unscrew the line-set tube close-off plate from the front left cabinet rail.
- 2) Remove the front drain pan support bracket (if supplied).
- 3) Slide the coil and drain pan assembly out of the unit.
- 4) **IMPORTANT:** Remove the plug from one of the threaded holes in the horizontal drain pan. Completely remove the webbing located in the threaded holes of the drain pan. If webbing is not removed, the

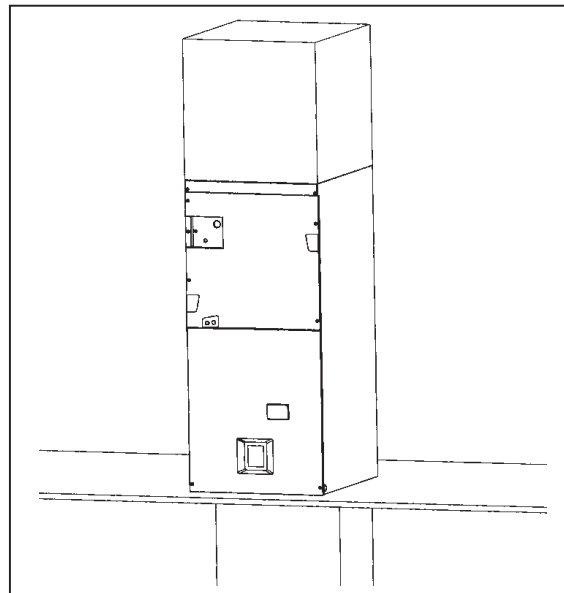

Figure 3. Downflow Installation

drain will not function properly and ceiling damage may occur.

- 5) Remove the sheet metal hairpin covers (if supplied) from the back of the coil and discard.
- 6) Place the horizontal drain pan on the opposite side of the coil. On units with 2 sets of knockouts, remove the other set of knockouts in the coil spacing plates and insert support rod.
- 7) Insert a plug (from the horizontal drain pan) into the open and unused drain hole in the drain pan at the bottom of the unit to block bypass air.
- 8) Slide the coil and the horizontal drain pan assembly back into the unit. Reattach the tube close off plate.
- 9) Remove the corresponding drain line knockout from the coil access door to allow access to the horizontal drain.
- 10) Replace the door and attach the drain line.

The unit may also be installed in a horizontal application with the unit suspended from the ceiling. A typical installation of the unit in a suspended horizontal application is shown in Figure 5.

The field-supplied hanger straps must be connected to the unit within 2 inches of the inlet end of the unit and within 4 inches of the outlet end of the unit as shown in Figure 5. If the straps pass in front of the unit, leave adequate room for removal of the doors and filter.

! CAUTION:

Make certain that the fasteners used to connect the hanger straps to the unit do not contact internal wiring or refrigerant tubes.

NOTE: In all horizontal applications in which the unit is installed above a finished ceiling and/or living space, a secondary drain pan must be installed under the entire unit to avoid damage to the ceiling in the event of condensate overflow.

Supply Air Ducts — Bend up the flanges on the top of the unit and connect the supply air duct over them. Secure the duct to the flange, using appropriate fasteners for the type of duct used. Seal the joint between the duct and the unit to avoid air leakage and sweating. The

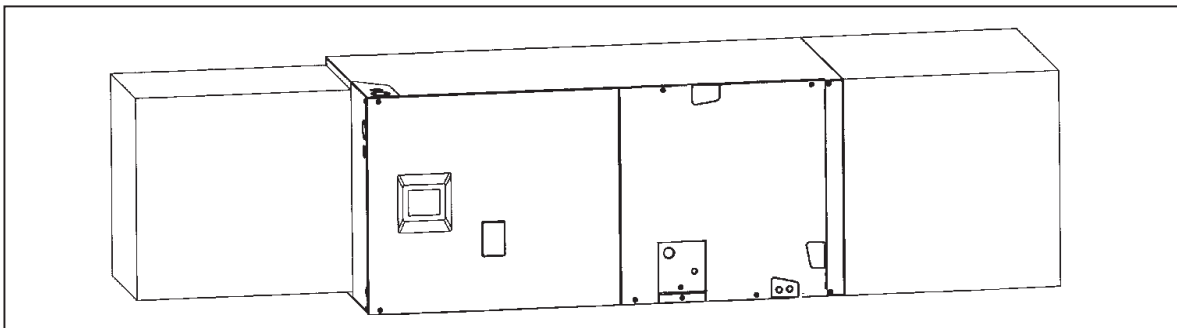

Figure 4. Horizontal-left Installation

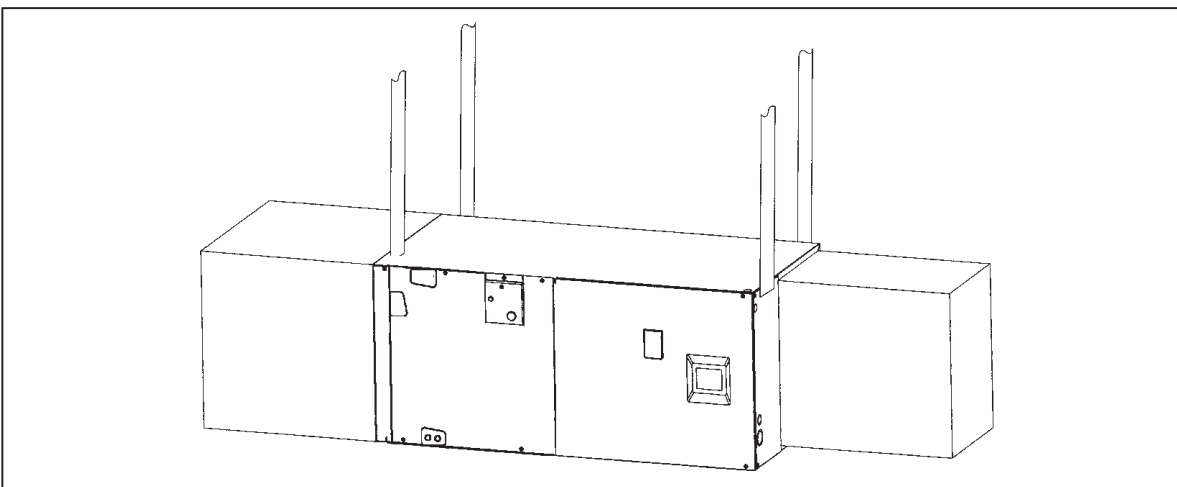

Figure 5. Horizontal-right Installation, Suspended from Ceiling

supply air ductwork must be of noncombustible material for the first 24 inches from the unit.

Some installations with a short, straight run from the unit to the first branch takeoff may require acoustical lining inside the supply air ductwork. Acoustical insulation must be in accordance with the current revision of the Sheet Metal and Air Conditioning Contractors National Association (SMACNA) application standard for duct liners.

Duct lining material must be UL classified batts or blankets with a fire hazard classification of FHC-25/50 or less. Fiber ductwork may be used in place of internal duct liners if the fiber ductwork is in accordance with the current revision of the SMACNA construction standard on fibrous glass ducts.

Fibrous ductwork and internal acoustical lining must be NFPA Class I air ducts when tested per UL Standard 181 for Class 1 ducts.

Through-the-Floor Installations — Whenever the supply or return air ducts pass through the floor, a 1/4" thick noncombustible resilient gasket must be used between the duct, unit and floor.

Ductwork in Unconditioned Spaces — All ductwork located in unconditioned space must be adequately insulated to prevent excess duct loss and condensation. All externally insulated ductwork must have an adequate vapor seal. Consult your Distributor for the recommended type and thickness of insulation for your area.

4. REFRIGERANT TUBING CONNECTIONS

Note: Do not remove seals from the coil until tubing connections are ready to be made. See the instructions packaged with the condensing unit for the correct procedure for connection of the refrigerant lines.

Note: The air handler coil does not contain a refrigerant charge. Reference installation instructions included with outdoor unit for information regarding the refrigerant charge included in the outdoor unit.

The restrictor employed in these air handlers has been sized for use with the most popularly matched A/C outdoor unit. The restrictor size in the coil as shipped from the factory is listed on the air handler rating plate. Check that the

restrictor orifice size provided with the air handler is correct for the outdoor unit being applied. If the restrictor orifice size is incorrect it should be replaced as follows:

1. Loosen the orifice body halves by applying two wrenches and squeezing them together as shown in Figure 6, to turn the assembly nut counterclockwise.
2. Continue to unscrew the assembly nut to separate it from the distributor body.
3. Insert a light-gauge wire hook between the distributor body and the restrictor orifice to lift the orifice out of the body (See Figure 7). Carefully remove the restrictor orifice being careful not to scratch either part.
4. Check the actual size of the new restrictor orifice (the size is stamped on the side of the orifice).

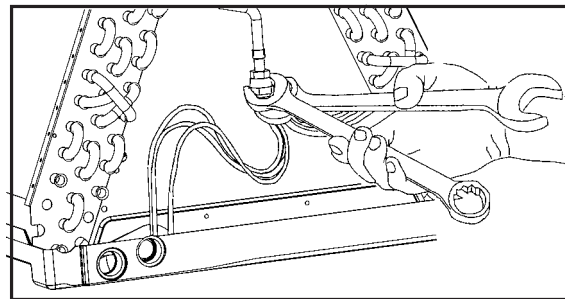

Figure 6. Wrenches on Distributor Body and Assembly Nut

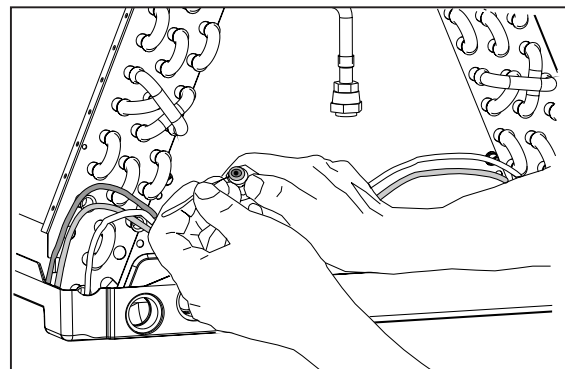

Figure 7. Removal of Orifice

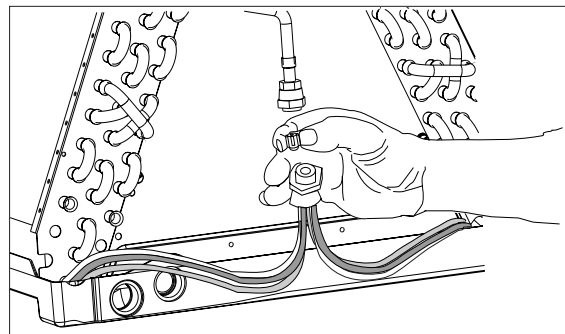

Figure 8. Restrictor Insertion in Distributor Body

5. Insert the new restrictor orifice in the distributor body as shown in Figure 8.
6. After installing the orifice in the distributor body, re-attach the assembly nut to the distributor body and tighten it to 10-12 ft/lbs of torque. If no torque wrench is available, mark a line along both the nut and body after hand tightening and then tighten an additional 1/4 turn. The misalignment of the two lines will show how much the nut is tightened.
7. Check the assembly for leaks after refrigerant pressure is applied.

 **WARNING:**

To avoid the risk of electric shock, personal injury or death, disconnect all electrical power to the unit before performing any maintenance or service. The unit may have more than one electrical power supply.

5. ELECTRICAL WIRING

General — Electrical power wiring must be made in accordance with all applicable local codes and ordinances, and with the current revision of the National Electric Code (ANSI/NFPA 70). If any of the original wire as supplied with the unit must be replaced, it must be replaced with wire material having the same gauge and temperature rating.

Line Voltage — Before proceeding with the electrical connections, make certain that the voltage, frequency, and phase of the supply source are the same as those specified on the rating plate. Also, verify that the service provided by the utility is sufficient to handle the additional load imposed by this equipment.

See the unit wiring label for proper high and low voltage wiring. Make all electrical connections in accordance with the National Electric Code and any applicable local codes or ordinances.

Use a separate branch electrical circuit for this unit. A disconnecting means must be located within sight of, and readily accessible to, the unit. When electric heat packages with circuit breakers are field-installed, the circuit breaker may be used as a disconnecting means in most applications. Reference the NEC and Local Codes for Disconnect requirements.

208/240 volt units are shipped from the factory wired for 240 volt transformer operation. For 208 volt operation, remove the lead from the transformer terminal marked 240v and connect it to the terminal marked 208v. For maximum ampacity and overcurrent protection, see Table 1.

Provide power supply (or supplies) for the unit in accordance with Table 1, the unit wiring diagram and the unit rating plate. Connect the line-voltage leads to the corresponding pigtails (or marked terminals on the circuit breaker when the field installed circuit breaker kits are used) inside the control compartment. Replace the power plug with the heater kit plug when installing a heater kit. Use copper wire only for the line voltage power supply to this unit. Aluminum supply wire may be used if a heater kit is installed. Use UL listed conduit and a conduit connector for connecting the supply wires to the unit and for obtaining proper grounding. Grounding may also be accomplished by using the grounding lug provided in the control box.

 **WARNING:**

The unit cabinet must have an uninterrupted and unbroken electrical ground to minimize the risk of personal injury if an electrical fault should occur. This ground may consist of electrical wire or approved conduit when installed in accordance with existing national or local codes.

Low Voltage — Install the grommet, which is packed with the unit, in the hole for low-voltage wires. When the low voltage wires are positioned in this grommet, the grommet will prevent chafing and/or shorting of the low voltage leads. Connect the low-voltage wiring to the thermostat and the outdoor unit and the appropriate pigtail terminal.

NOTE: Where local codes require that the thermostat wiring must be routed through a conduit or raceway, splices can be made inside the unit; however, all wiring must be NEC Class 1 and must be separated from incoming power leads.



CAUTION:

Isolation must be maintained from the external Class 2 output of any transformer in a cooling circuit. Use a thermostat with isolating contacts to prevent inter-connection of Class 2 outputs.

Check all factory wiring per the unit wiring diagram and inspect the factory wiring connections to be sure none were loosened in transit or installation.



CAUTION:

Make sure all doors are installed before restoring power to the unit.

6. START-UP AND ADJUSTMENT

General — Prior to start-up, verify that:

1. The line voltage power leads are securely connected and that the unit is properly grounded.
2. The low voltage wires are securely connected to the correct leads from the unit.
3. The upper and lower doors are in place and securely connected to the unit.

Selecting Proper Blower Speed for Multi-Speed Units — The blower speed is preset at the factory for operation at the same speed for heating and cooling. For optimum system performance and comfort, it may be necessary to change the factory set speed. To change the blower speed, disconnect all electrical power to the unit and remove the upper door.

Connect the blower wire (black) to the desired blower speed marked on the terminal block of the blower motor. Terminal 4 = Hi speed, terminal 5 = Med speed and terminal 6 = Low speed.

Replace the upper door and secure it to the unit. Restore power to the unit.

7. CARE AND MAINTENANCE

General — For continued high performance, and to minimize the risk of equipment failure, it is essential that periodic maintenance be performed on this equipment. The ability to properly perform maintenance on this equipment requires certain mechanical skills and tools. If you do not possess these skills, contact your dealer for maintenance. Consult your local dealer as to the availability of a maintenance contract.

Do not store any of the following on, or in contact with, the unit: Rags, brooms, vacuum cleaners, or other cleaning tools, spray or aerosol cans, soap powders, bleaches, waxes, cleaning compounds, plastics or plastic containers, paper bags or other paper products, gasoline, kerosene, cigarette lighter fluid, dry cleaning fluids, paint thinners, or other volatile fluids.

Proper maintenance is most important to achieve the best performance from an air handler. At a minimum, this maintenance should include the following items.

1. Inspect and clean or replace the air filter at the beginning of each heating and cooling season, or more frequently as required.
2. Inspect the cooling coil, drain pan, and condensate drain at the beginning of each cooling season for cleanliness. Clean these components as necessary using a mild detergent and water. Flush the coil, drain pan, and condensate drain after cleaning to remove all detergent. Use caution when cleaning these components so that the insulation does not become wet.
3. Inspect the blower motor and wheel for cleanliness at the beginning of each heating and cooling season. Clean the motor as necessary.
4. Inspect electrical connections for tightness at the beginning of each heating and cooling season. Service as necessary.



WARNING:

Use caution when removing parts from this unit. Personal injury can result from sharp metal edges present in all equipment of sheet metal construction.

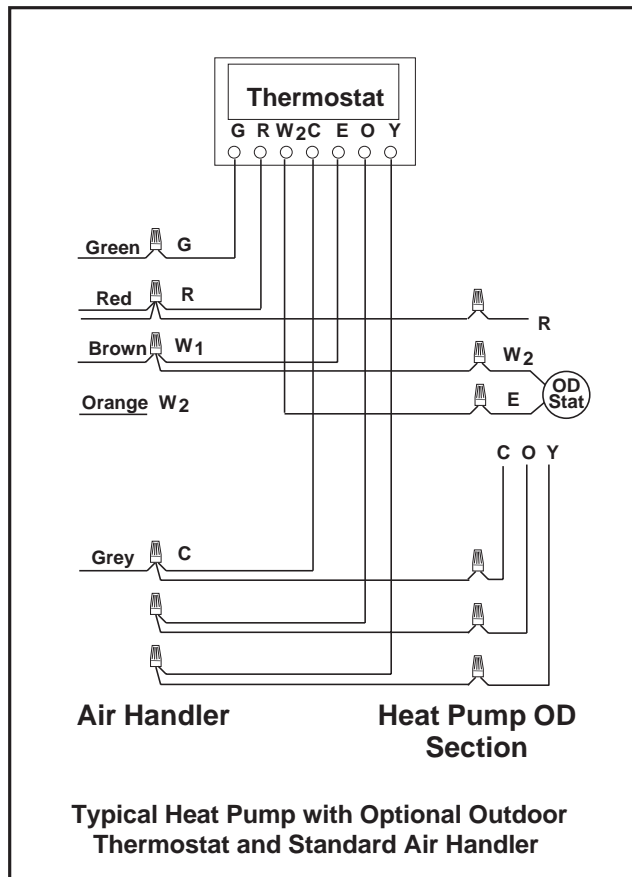
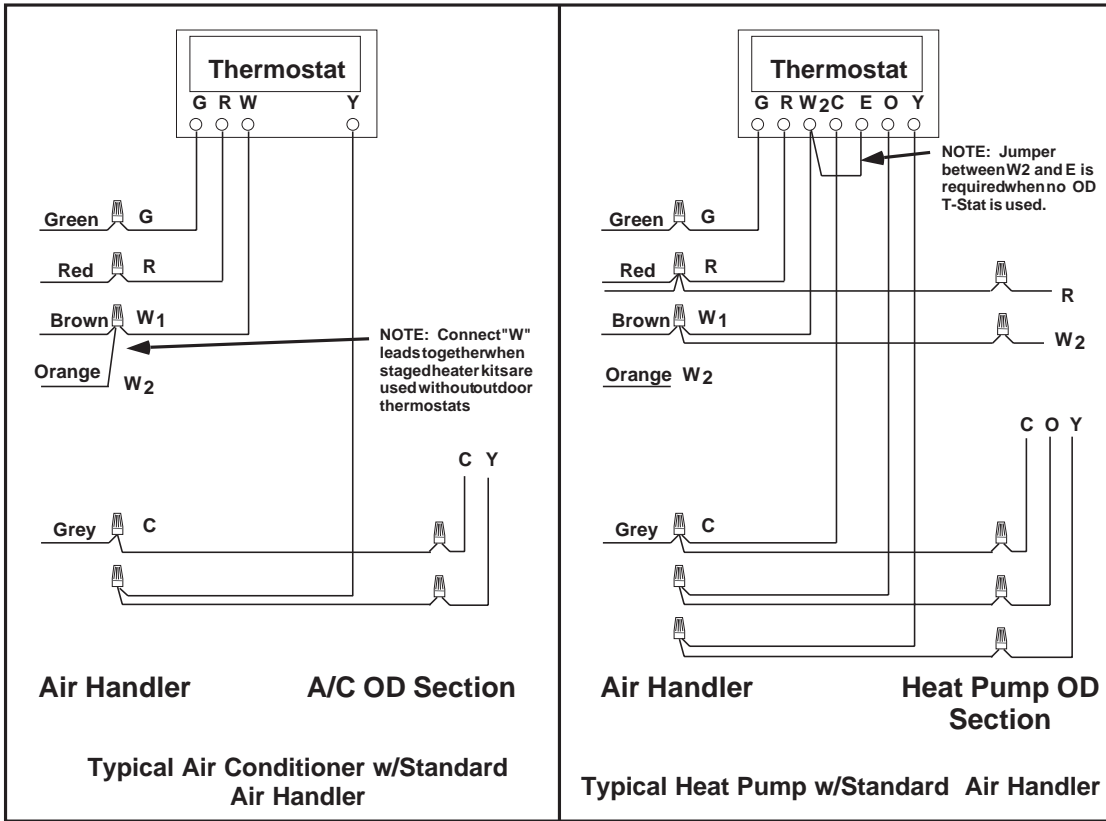

Figure 9. Typical Air Conditioning and Heat Pump System Connections

**INSTALLER: PLEASE LEAVE THESE INSTALLATION
INSTRUCTIONS WITH THE HOMEOWNER**

7081940



Specifications and illustrations subject to change
without notice and without incurring obligations.
Printed in U.S.A. (10/02)